



Spare parts for:

Bar equipment



Suitable for:

ZANUSSI



This catalogue is automatically generated.
Therefore, the sequence of the items might
not be always shown at best.
Updates will be issued in case of additions
and/or amendments.

Suitable universal spare parts may not be included





SANDWICH TOASTER DPG/RCE

DPG/RCE

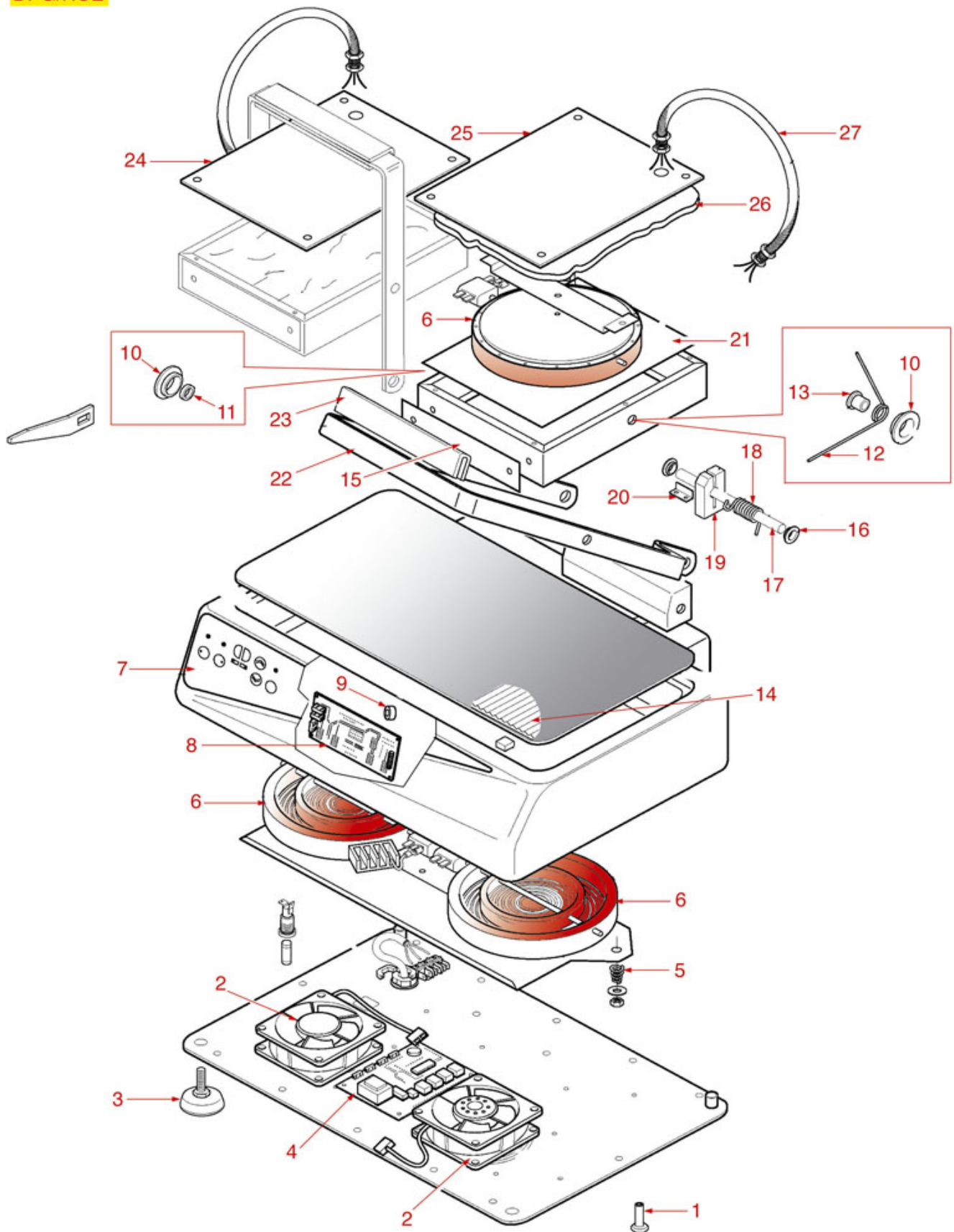



ZANUSSI



Position	LF code no.	Description
2	3240501	AXIAL VENTILATOR SUNON 120x120x38 mm
6	3311046	ELECTRIC HOT PLATES (PAIR) 1800W 230V
8	3390086	DISPLAY CIRCUIT BOARD 185x50 mm
18	3250141	SPRING ø 21x75 mm



ZANUSSI



Position	LF code no.	Description
4	3240501	AXIAL VENTILATOR SUNON 120x120x38 mm
5	3445144	TEMPERATURE PROBE NTC 1000 mm
9	3390086	DISPLAY CIRCUIT BOARD 185x50 mm
15	3250141	SPRING \varnothing 21x75 mm



Suitable for:

ZANUSSI



Suitable for:

Bearings

5009467 BEARING 6007 2RS
extern.ø 62 mm - intern.ø 35 mm - thickness 14 mm

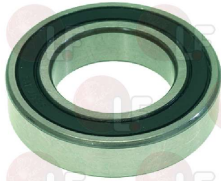

ZANUSSI 0HD046

1063005 BEARING 6201 2RS
external ø 32 mm-internal ø 12 mm-thickness 10 mm

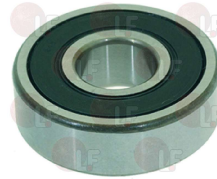

ZANUSSI 0D5346

ZANUSSI 072019

3063005 BEARING 6202 2RS
external ø 35 mm -internal ø 15 mm-thickness 11 mm



ZANUSSI 0D0035

ZANUSSI 072751

1063911 BEARING 6202 2Z
external ø 35 mm-internal ø 15 mm-thickness 11 mm



ZANUSSI 056820

3063017 BEARING 6203 2RS
external ø 40 mm -internal ø 17 mm-thickness 12 mm

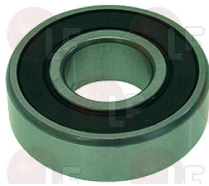

ZANUSSI 0D0821

ZANUSSI 0KJ007

ZANUSSI 089918

Burners and flame spreaders

3025364 BURNER BOWL ø 78 mm
for Crêpe pan gas (FIMAR) CR400G1 - CR400G2



ZANUSSI 004977

3025363 FLAME SPREADER ø 120 mm
for Crêpe pan gas (FIMAR) CR400G1 - CR400G2



ZANUSSI 004975

3025364 BURNER BOWL ø 78 mm
for Crêpe pan gas (FIMAR) CR400G1 - CR400G2



ZANUSSI 004977



Suitable for:

3025362 FLAME SPREADER ASSY. ø 120 mm
for Crêpe pan gas (FIMAR) CR400G1 - CR400G2



ZANUSSI 004974

3025362 FLAME SPREADER ASSY. ø 120 mm
for Crêpe pan gas (FIMAR) CR400G1 - CR400G2

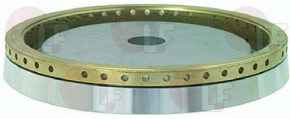

ZANUSSI 004974

ZANUSSI



Suitable for:

Capacitors

3068016 CAPACITOR µF 10 450V 50/60Hz
operating temperature -25+85°C
in compliance with EEC 93/68 and 92/31 regulations



ZANUSSI 0U0403

ZANUSSI 056148

3068024 CAPACITOR µF 16 450V 50/60Hz
operating temperature -25+85°C
in compliance with EEC 93/68 and 92/31 regulations



ZANUSSI 0A2914

ZANUSSI 0C1187

ZANUSSI 0H6812

3068002 CAPACITOR µF 2.5 450V 50/60Hz
operating temperature -25+85°C
in compliance with EEC 93/68 and EEC 92/31 regulat



ZANUSSI 0E0174

3068027 CAPACITOR µF 20 450V 50/60Hz
operating temperature -25+85°C
in compliance with EEC 93/68 and 92/31 regulations



ZANUSSI 0H1044

ZANUSSI 047744

3068008 CAPACITOR µF 5 450V 50/60Hz
operating temperature -25+85°C
in compliance with EEC 93/68 and EEC 92/31 regulat

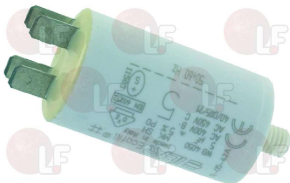

ZANUSSI 0K9108

ZANUSSI 037268

3068014 CAPACITOR µF 8 450V 50/60Hz
operating temperature -25+85°C
in compliance with EEC 93/68 and 92/31 regulations



ZANUSSI 049126



Suitable for:

ZANUSSI



Suitable for:

Clamps

3449405 DOUBLE-WIRE CLAMP 9.8-10.4 - 100 PCS
for hoses \varnothing 9.8÷10.4 mm



ZANUSSI 0E5993

ZANUSSI 0L0815

3449462 HOSE CLAMP 12-20
for hoses \varnothing 12÷20 mm
made of stainless steel AISI 304
height 9 mm and screw E7



ZANUSSI 049888

3449452 HOSE CLAMP 16-25
for hoses \varnothing 16÷25 mm
made of stainless steel AISI 304
height 9 mm and screw E7



ZANUSSI 048126

3449466 HOSE CLAMP 16-27
for hoses \varnothing 16÷27 mm
made of stainless steel AISI 304
height 12 mm and screw E7



ZANUSSI 0E5120

ZANUSSI 0E900

3449453 HOSE CLAMP 25-40
for pipes \varnothing 25÷40 mm
made of stainless steel AISI 304
height 9 mm and screw E7



ZANUSSI 047578

3449456 HOSE CLAMP 50-70
for hoses \varnothing 50÷70 mm
made of stainless steel AISI 304
height 9 mm and screw E7



ZANUSSI 0E1358

ZANUSSI 0K8983

ZANUSSI 046855

3449457 HOSE CLAMP 60-80
for pipes \varnothing 60÷80 mm
made of stainless steel AISI 304
height 9 mm and screw E7



ZANUSSI 046853

3449476 HOSE CLAMP 70-90
for hoses \varnothing 70÷90 mm
made of stainless steel AISI 304
height 12 mm and screw E7



ZANUSSI 0E1354

Suitable for:

Suitable for:

3449461 HOSE CLAMP 8-12
for hoses \varnothing 8÷12 mm
made of stainless steel AISI 304
height 9 mm and screw E7



ZANUSSI 046946

ZANUSSI 048224

Electric hot plates

3311046 ELECTRIC HOT PLATES (PAIR) 1800W 230V
 \varnothing 215 mm
faston connections
for Panini grill (ZANUSSI) DPG/RCE



ZANUSSI 0C1809

ZANUSSI 0D6989

Electronic printed-circuit boards

3390086 DISPLAY CIRCUIT BOARD 185x50 mm
cable length 500 mm
for Panini grill (ZANUSSI) - Series DH
Series DPG - Series EH - Series EPG

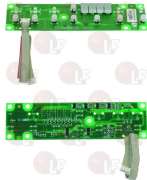

ZANUSSI 087481

Energy regulators

3350026 ENERGY ADJUSTER
contact capacity 230V 13A - max temperature 125°C
D-shaped pin \varnothing 6x4.6 mm
double rotation direction
for PYROCERAM. TOPS-SALAMANDERS-POTATO WARMERS
for Sausage grill (CF CENEDESE)
for Toaster (CF CENEDESE)
for Toaster electric (DOSILET) GG4000 - TT6000

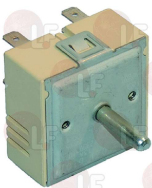

ZANUSSI 0A2482

ZANUSSI 0C1605

ZANUSSI 0K8611

ZANUSSI 005270

ZANUSSI 026861

ZANUSSI 055016



Suitable for:

ZANUSSI



Suitable for:

Filters

3160913 ANTIACID DEHYDRATOR FILTER 4305/2
1/4"MM sae lenght 119 mm \varnothing 52 mm
with solid cartridge - CODE INT.052
nominal cubature 80 cm³



ZANUSSI 086312

3160244 COPPER FILTER 30 g
2 ways - inlet 6.5 mm outlet 6.5 mm
 \varnothing 24 mm - length 140 mm



ZANUSSI 0A9410

Fittings

3526812 ACCES VALVE WITH TUBE 10 cm \varnothing 6 mm



ZANUSSI 0A8171

Gas taps and accessories

3348014 GAS COCK 20/S
without pilot flame
fittings \varnothing M16x1.5mm
thermocouple fitting M8x1
D-shaped pin \varnothing 8x6.5mm



ZANUSSI 0A2163
ZANUSSI 054629

ZANUSSI 054109

ZANUSSI 054628

3348020 CAP WITH PIN \varnothing 8x6.5 mm
pin length 22 mm
for model PEL 20S

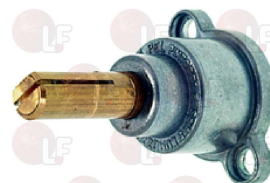

ZANUSSI 059854

3182011 MAGNETIC UNIT PEL SMALL HEADED
 \varnothing head 15 mm - \varnothing end 11 mm - length 44 mm
for PEL tap models 20-21
for EGA tap model 25213
for JUNKERS tap model CH110



ZANUSSI 056595

3348043 PIPE FITTING \varnothing 10 mm
for model PEL 20-21



ZANUSSI 0A2125



Suitable for:

3348044 PIPE OLIVE \varnothing 10 mm
for model PEL 20 - 21

Suitable for:



ZANUSSI 060325

Gaskets and seals

3186143 GASKET OR 04093 EPDM



ZANUSSI 050292

ZANUSSI 086551

1186231 O-RING GASKET 04106 EPDM



ZANUSSI 027300

3243069 O-RING OR 02068 EPDM



ZANUSSI 047987

3243139 O-RING 02025 EPDM



ZANUSSI 067898

ZANUSSI 086109

3243191 O-RING 02125 EPDM



ZANUSSI 046861

3243142 O-RING 04118 EPDM



ZANUSSI 027301

3186860 OR GASKET 03056 EPDM
EX OR 0118



ZANUSSI 0KK400

ZANUSSI 068642



Suitable for:

ZANUSSI



Suitable for:

Greases

- 3180006 GREASE NONTROP/PLBDR 1000 g**
 high quality grease
 for water tap lubrication
 physiologically harmless, unscented, tasteless



ZANUSSI 0S0004

Heating elements

- 3755021 HEATING ELEMENT 875W 240V TOP**
 length 190 mm - width 310 mm
 for Panini grill (SIRMAN) CORT - ELIO



ZANUSSI 0SI277

Inlet hoses

- 3449001 INLET ELBOW HOSE \varnothing 3/4" FF 150 cm**
 pipe \varnothing 10x16 mm
 nylon fittings \varnothing 3/4" with gaskets
 max temperature 90°C
 max pressure 10 bar



ZANUSSI 0S0150

ZANUSSI 053789

Ironmongery (screws,nuts,washers)

- 1528030 ST.STEEL HEXAGONAL NUT M6 UNI 5588**



ZANUSSI 0K4516

- 1186192 WASHER M5x10 mm UNI 6592**



ZANUSSI 0E1119

Knobs

3241243 BLACK KNOB \varnothing 39 mm SILK-SCREEN PRINTED
D shaft hole 6x4.6 mm

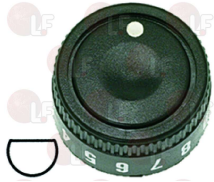

ZANUSSI 003029

Lamps

3221132 GREEN INDICATOR LAMP 230V
head \varnothing 13.5 mm - hole \varnothing 10 mm - 120°C
universal application



ZANUSSI 004169

ZANUSSI 058544

3221164 GREEN INDICATOR LAMP 230V
head \varnothing 7 mm - hole \varnothing 6 mm - 120°C
dashboard mounting



ZANUSSI 054150+054151

3221045 GREEN LAMP CAP \varnothing 7 mm



ZANUSSI 054151

3221192 LAMP SUPPORT



ZANUSSI 0A8268

3221250 NEUTRAL HALOGEN LAMP G4 10W 12V
for OVEN



ZANUSSI 0H7038

3221105 NEUTRAL HALOGEN LAMP G4 20W 12V
for MORETTI OVEN M90C-M130C



ZANUSSI 0C2803

ZANUSSI 002956

ZANUSSI 007056

3221097 NEUTRAL INDICATOR LAMP 220V
head \varnothing 8 mm - 120°C



ZANUSSI 004895

ZANUSSI 048832

ZANUSSI 046241

ZANUSSI 048488



Suitable for:

3221095 ORANGE INDICATOR LAMP 230V
head \varnothing 13.5 mm - hole \varnothing 10 mm - 120°C
universal application



ZANUSSI 005215

ZANUSSI 058522

Suitable for:

3221014 ORANGE INDICATOR LIGHT 220V
mounting hole 30x22 mm - 125°C
universal application
for MORETTI PROOFING CABINET AHL-MHL-RHL-P110L
F80L-TVHL-AMALFI L-P60/80/120EL-F80/40EL-L60.60
L65.105-L105.105-L105.65-TEVERE HI/TECH

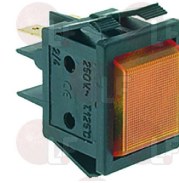

ZANUSSI 0KM981

Microswitches

3240401 ACTUATOR FOR MICROSWITCH
for OVEN



ZANUSSI 054902

3240407 MECHANICAL MICROSWITCH KIT 16A 250V
3 locking positions
the kit includes 5 levers:
lever 75 mm - lever 27 mm - lever 15 mm
lever 15 mm with wheels - lever 27 mm with wheels

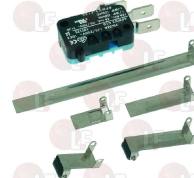

ZANUSSI 069484

3240144 MICROSWITCH S16 16A 250V



ZANUSSI 0W2466

3240123 MICROSWITCH 16A 250V
for Granita machine (UGOLINI) GIANTGL - MTGL
MTMINI
for Ice crusher (SANTOS) 9
for Mixer (ROBOT COUPE) MP350 - MP450 - MP550
MP550A - MP600 - MP600A



ZANUSSI 0KI505

3240151 MICROSWITCH 16A 250V
for ZANUSSI TRAINO RT
for BIANCHI LEVEL TANK
for Blender (SAMMIC) BB-900 - TB-1000



ZANUSSI 0E0209

ZANUSSI 004904

ZANUSSI 047485

3240152 BUSHING FOR MICROSWITCH

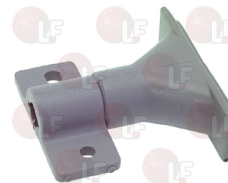

ZANUSSI 047487



Suitable for:

3240473 GASKET FOR BUSHING



ZANUSSI 047490

3240154 SPRING FOR MICROSWITCH ROD

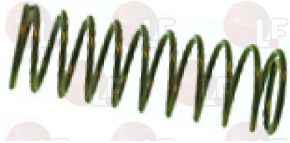

ZANUSSI 047489

3240820 MICROSWITCH 16A 250V

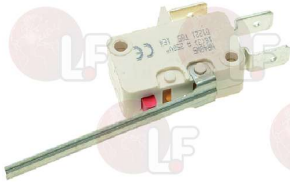

ZANUSSI 0KB678

ZANUSSI 046286

ZANUSSI 047485

3240166 MOUNTING PLATE FOR MICROSWITCH
external dimensions 46x26 mm

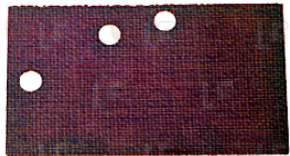

ZANUSSI 045404

ZANUSSI 45404

3240166 MOUNTING PLATE FOR MICROSWITCH
external dimensions 46x26 mm

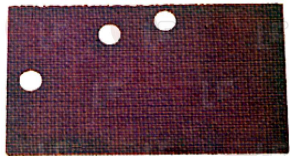

ZANUSSI 045404

ZANUSSI 45404

ZANUSSI



Suitable for:

3240153 ROD FOR MICROSWITCH



ZANUSSI 047488

3240401 ACTUATOR FOR MICROSWITCH
for OVEN



ZANUSSI 054902



Suitable for:

ZANUSSI



Suitable for:

Motors

3240519 AXIAL FAN EBM 119x119x38 mm
4650N - 230V 50Hz 19W - 2650 Rpm
ball bearing



ZANUSSI

3240502 AXIAL FAN SUNON 80x80x25 mm
ball bearings
14W 230V 50/60Hz 2450 Rpm
SF23080AT-2082HBL.GN



ZANUSSI 006125

3240501 AXIAL VENTILATOR SUNON 120x120x38 mm
ball bearings
22W 230V 50/60Hz 2850 Rpm
DP200A 2123XBT.GN
for Granita machine (UGOLINI) MINIGEL - MTMINI



ZANUSSI 0C1478
ZANUSSI 0E2261
ZANUSSI 058855

ZANUSSI 0C4106
ZANUSSI 002656

ZANUSSI 0C4423
ZANUSSI 002690

3240220 SUCTION BLADE ø 200 mm 28°



ZANUSSI 0KM741

ZANUSSI 082874

ZANUSSI 084041

3240222 SUCTION BLADE ø 230 mm 28°



ZANUSSI 0A8420

ZANUSSI 082230

3240964 SUCTION BLADE ø 250 mm 28°



ZANUSSI 086311

3240211 5-POLE MOTOR ELCO 10W
230/240V 50/60Hz 1300Rpm - 38W Input
VN 10-20



ZANUSSI 0S0561

ZANUSSI 081393

ZANUSSI 086207

3240220 SUCTION BLADE ø 200 mm 28°



ZANUSSI 0KM741

ZANUSSI 082874

ZANUSSI 084041

3240902 5-POLE MOTOR ELCO 16W
230/240V 50/60Hz 1300Rpm - 65W Input
VN 16-25



ZANUSSI 0S0562

ZANUSSI 086310

3240220 SUCTION BLADE ø 200 mm 28°



ZANUSSI 0KM741

ZANUSSI 082874

ZANUSSI 084041

Suitable for:

Suitable for:

3240210 5-POLE MOTOR ELCO 5 W
230/240V 50/60Hz 1300Rpm - 32W Input
VN 5-13



ZANUSSI 0KD790

Piezo ignitors

3001020 PIEZO IGNITER 10015
18 mm \varnothing mounting hole
2.4 mm \varnothing male faston connector



ZANUSSI 0A2127

ZANUSSI 059251

Probes

3445144 TEMPERATURE PROBE NTC 1000 mm
2-wire probe
bulb \varnothing 4x40 mm
for FRYER series N900-HD900



ZANUSSI 006609

Relays

3351158 BASE UNDECAL ES11 10A 400V
11 poles

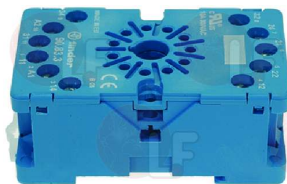

ZANUSSI 049236

3351021 RELAY 62.82 16A 230V 50/60Hz
2 switching contacts

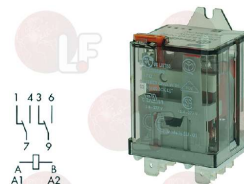

ZANUSSI 0PE302



Suitable for:

ZANUSSI



Suitable for:

3351008 RELAY 62.83 16A 230V 50/60Hz
 3 switching contacts
 for CIMBALI MAGNUM-SPECIAL-6/S-6/SNEW
 for FAEMA MD3000
 for SILANOS 030A-N50/90/700-E1000

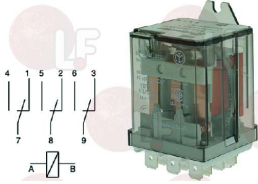

ZANUSSI 0A9596
ZANUSSI 088197

ZANUSSI 005033

ZANUSSI 005034

Remote control switches

3446223 CONTACTOR AEG LS02K 6A 230V 2.2Kw
 coil 230V 50/60Hz
 4 normally open contacts
 no auxiliary contact

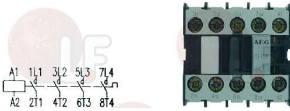

ZANUSSI 004159

Rotary switches

3057019 SELECTOR SWITCH 0-1 POSITIONS
 contact capacity 16A 250V - max 150°C
 D-shaft \varnothing 6x4.6 mm

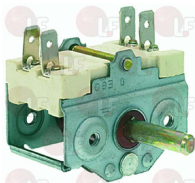

ZANUSSI 0A2227

ZANUSSI 003142

3057026 SELECTOR SWITCH 0-1 POSITIONS
 contact capacity 16A 250V - max 150°C
 D shaft \varnothing 6x4.6 mm
 for Toaster electric (DOSILET) TT0001 - TT4000

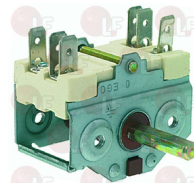

ZANUSSI 054375

3057022 SELECTOR SWITCH 0-1 0-1 POSITIONS
 contact capacity 16A 250V - max 150°C
 D-shaft \varnothing 6x4.6 mm
 for Toaster electric (DOSILET) TT0001 - TT4000

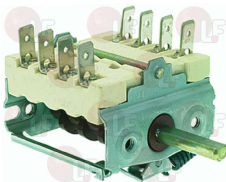

ZANUSSI 0A2241

3057076 SELECTOR SWITCH 0-6 POSITIONS
 contact capacity 16A 250V - max 150°C
 D shaft \varnothing 6x4.6 mm

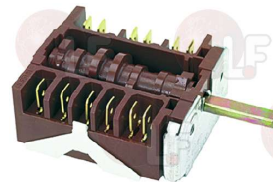

ZANUSSI 059238

Springs

3250141 SPRING \varnothing 21x75 mm
for SANDWICH PLATE DPG/RCE



ZANUSSI 0C1836

Switches

3319920 BLACK TWO-POLE SWITCH 16A 250V



ZANUSSI 0A8754

3319570 DRAIN GREY KEY



ZANUSSI 049325

3319012 GREEN BIPOLAR SWITCH 16A 250V
with indicator light and switch cover
screen printing 0 - I
max temperature 120°C
mounting hole 22x30 mm



ZANUSSI 053810

3319928 GREEN BIPOLAR SWITCH 16A 250V
with indicator lamp
max. temperature 120°C
mounting hole \varnothing 25 mm



ZANUSSI 054518

3319151 SWITCH PROTECTION CAP
 \varnothing external 34 mm
for push-buttons with mounting hole \varnothing 25 mm



ZANUSSI 053979

3319944 GREEN BIPOLAR SWITCH 16A 250V
with indicator light
0-I silk-screen printing
temperature max 120°C
mounting hole 22x30 mm



ZANUSSI 056703

3319972 GREEN BIPOLAR SWITCH 16A 250V
with indicator lamp
ON - OFF silk-screen printing
max temperature 120°C
mounting hole 22x30 mm

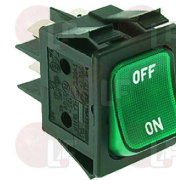

ZANUSSI 082873



Suitable for:

ZANUSSI



1319202 GREEN TWO-POLE SWITCH 16A 250V

with indicator lamp
silk-screen printing 0 - I
temperature max 120°C
mounting hole 22x30 mm



ZANUSSI 056703

ZANUSSI 081680

Suitable for:

3319088 ORANGE BIPOLAR SWITCH 250V 16A

with indicator lamp and push-button cover
temperature max 120°C
mounting hole 22x30 mm
for Juice extractor (SANTOS) 10

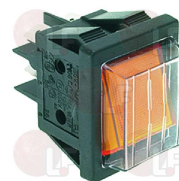

ZANUSSI 056878

ZANUSSI 056879

ZANUSSI 056880

3319921 SINGLE-POLE SWITCH 16A 250V



ZANUSSI 0A8274

3319923 BLACK/RED CAM



ZANUSSI 0A8272

Terminal blocks

3247006 2-POLE CERAMIC TERMINAL BLOCK

for cable max 6 mm²
operating temperature 300°C
nominal voltage 450V
dimensions 25x22x21 mm



ZANUSSI 053805

3247016 3-POLE TERMINAL BLOCK FV273 40A 450V

for cable max 6 mm²
operating temperature 150°C
nominal voltage 450 V



ZANUSSI 046357

3247005 4-POLE CERAMIC TERMINAL BLOCK

for cable max 2.5 mm²
operating temperature 300°C
nominal voltage 450V
dimensions 40x18x16 mm



ZANUSSI 054042

3247011 6-POLE TERMINAL BLOCK FV122 40A 600V

for cable max 6 mm²
operating temperature 150°C
nominal voltage 450 V

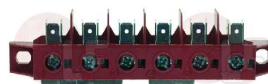

ZANUSSI 046347

Suitable for:

Suitable for:

3247009 6-POLE TERMINAL BLOCK FV122/B 40A 600V
 for cable max 6 mm²
 operating temperature 150°C
 nominal voltage 450 V



ZANUSSI 005420

ZANUSSI 058613

Thermocouples and accessories

3440079 THERMOCOUPLE M8x1 60 cm.COUPLING M6x1

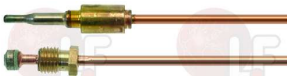

ZANUSSI 004955

Thermostats

3444174 SINGLE-PHASE THERMOSTAT 50-320°C
 D-shaped pin \varnothing 6x4.6 mm
 capillary length 900 mm - 16A 250V
 bulb \varnothing 3x220 mm



ZANUSSI 005421

3444919 THERMOSTAT RANCO K50 P1115
 2 contacts 6A 250V
 capillary 2000 mm
 COLD +1.5°C - WARM +11.0°C
 D shaft \varnothing 6x4.6 mm

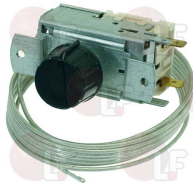

ZANUSSI 083520

3441906 SPRING FOR KNOB



ZANUSSI 082792



Suitable for:

3241905 THERMOSTAT KNOB \varnothing 26 mm
hole \varnothing 6x4 mm



ZANUSSI 081690

3444007 THERMOSTAT TR2 0-300°C
D-shaped pin \varnothing 6x4.6 mm
capillary length 1500 mm - 15A 250V
bulb \varnothing 3.5x190 mm



ZANUSSI 054323

Timers

3446004 TIMER 120 MINUTES
mechanical timer with acoustic signal
mechanical movement with balance wheel
manual operating position on the left
manual winding cycle 120 minutes
bipolar timer with contact capacity 16(3)A 250V
max temperature 125°C
D shaft \varnothing 6x4.6 mm
complete with screenprinted label
for OVEN



ZANUSSI 003431

Tools

3394038 GROOVED FRYTOP SCRAPER



ZANUSSI 056940

ZANUSSI



Suitable for:

Tools

3394406 SCRAPER
with 1 blade 102 mm



ZANUSSI 055995

3394408 SCRAPER BLADE - 10 PCS

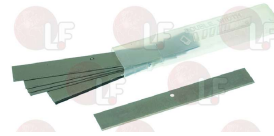

ZANUSSI 0C2519

ZANUSSI 056347

Water purification filters

3010617 PURITY CARTRIDGE C 500



ZANUSSI 0S1056

Water softeners and accessories

3010061 MANUAL WATER SOFTENER 12 L Ø 3/4"
stainless steel cylinder capacity 12 L
connection fittings 3/4"
dimensions: height 500 mm - Ø 185 mm
resin content 9 L
regeneration salt (NaCl-table salt) 1.5 Kg
for average dishwashers and dispensers
for 3-group coffee machines



ZANUSSI 0S0330

3010102 MANUAL WATER SOFTENER 12 L Ø 3/4"
plasma welding
STAINLESS STEEL cylinder capacity 12 L
connection fitting 3/4"
dimensions: height 500 mm - Ø 185 mm
resin content 9 L
regeneration salt (NaCl-table salt) 1.5 Kg
inlet water max temperature 60°C
for average dishwashers and dispensers,
for 3-group coffee machines



ZANUSSI 0S0330

3010006 MANUAL WATER SOFTENER 12 L WITH BY-PASS
stainless steel cylinder capacity 12 L
connection fittings 3/8"
dimensions: height 500 mm - Ø 185 mm
resin content 9 L
regeneration salt (NaCl-table salt) 1.5 Kg
for average dishwashers and dispensers
for 3-group coffee machines



ZANUSSI 0S0579

3010063 MANUAL WATER SOFTENER 20 L Ø 3/4"
stainless steel cylinder capacity 20 L
connection fittings 3/4"
dimensions: height 900 mm - Ø 185 mm
resin content 15 L
regeneration salt (NaCl-table salt) 3 Kg
for dishwashers, large automatic dispensers
for 4-group coffee machines



ZANUSSI 0S0329



Suitable for:

ZANUSSI



3010104 MANUAL WATER SOFTENER 20 L \varnothing 3/4"
 plasma welding
 STAINLESS STEEL cylinder capacity 20 L
 connection fitting 3/4"
 dimensions: height 900 mm - \varnothing 185 mm
 resin content 15 L
 regeneration salt(NaCl-table salt)3 Kg
 inlet water max temperature 60°C
 for dishwashers, large dispensers,
 for 4-group coffee machines



ZANUSSI 860430

Suitable for:

3010060 MANUAL WATER SOFTENER 8 L \varnothing 3/4"
 stainless steel cylinder capacity 8 L
 connection fittings 3/4"
 dimensions: height 400 mm - \varnothing 185 mm
 resin content 5.8 L
 regeneration salt(NaCl-table salt)1 Kg
 for cup washers, small automatic dispensers
 for 2-group coffee machines



ZANUSSI 0C1903

3010101 MANUAL WATER SOFTENER 8 L \varnothing 3/4"
 plasma welding
 STAINLESS STEEL cylinder capacity 8 L
 connection fitting 3/4"
 dimensions: height 400 mm - \varnothing 185 mm
 resin content 5.8 L
 regeneration salt(NaCl-table salt)1 Kg
 inlet water max temperature 60°C
 for cup washers, small automatic dispensers
 for 2-group coffee machines



ZANUSSI 0C1903

3010005 MANUAL WATER SOFTENER 8 L WITH BY-PASS
 stainless steel cylinder capacity 8 L
 connection fittings 3/8"
 dimensions: height 400 mm - \varnothing 185 mm
 resin content 5.8 L
 regeneration salt(NaCl-table salt)1 Kg
 for cup washers, small automatic dispensers
 for 2-group coffee machines



ZANUSSI 0S0578

3010601 PURITY CLEAN EXTRA 1200
 water softener suitable for DISHWASHERS
 specific for WARM WATER
 adjustable by-pass
 capacity at 10°KH 3100 L
 flow rate 300 L/h
 max pressure 6 bar
 min pressure 2 bar
 operating temperature 4°C/60°C
 pressure loss at flow rate 0.45 bar
 size: height 550 mm - \varnothing 255 mm
 weight: empty 18 Kg - full 24 kg
 fittings: inlet \varnothing 1"M - outlet \varnothing 3/4"M
 horizontal or vertical mounting



ZANUSSI 0S0803

3010600 PURITY CLEAN 1200
 water softener suitable for DISHWASHERS
 specific for WARM WATER
 adjustable by-pass
 capacity at 10°KH 12000 L
 flow rate 300 L/h
 max pressure 6 bar
 min pressure 2 bar
 operating temperature 4°C/60°C
 pressure loss at flow rate 0.45 bar
 size: height 550 mm - \varnothing 255 mm
 weight: empty 18 Kg - full 24 kg
 fittings: inlet \varnothing 1"M - outlet \varnothing 3/4"M
 horizontal or vertical mounting



ZANUSSI 0S0801



Suitable for:

3010604 PURITY ST 1200

water softener suitable COFFEE MACHINES-DISPENSERS
OVENS - ICE MAKERS
specific for ODOR REMOVAL
adjustable by-pass
capacity at 10°KH 13187 L
flow rate 200 L/h
max pressure 6.9 bar
min pressure 2 bar
operating temperature 4°C/30°C
pressure loss at flow rate 1.05 bar
dimensions: height 550 mm - ø 288 mm
weight: empty 18 Kg - full 24 kg
fittings: inlet ø 3/8" M - outlet ø 3/8" M
horizontal or vertical mounting



ZANUSSI 0S0682

Suitable for:

3010094 WATER SOFTENER "MATIC 12" 12 L ø 3/4"

AUTOTROL chronometric head 255/440i
230V 50Hz
time programmer mod.440 (weekly)
operating temperature 2°÷35°C
cylinder capacity 11.8 L - resin content 8 L
salt container 30 kg
regeneration salt(NaCl-table salt)1.5 Kg
inlet/outlet fittings 3/4"
dimensions: width 260 mm - depth 480 mm
height without head 435 - overall height 650 mm
We recommend to use always a mechanical filter
before the softener in order to remove
impurities from the water



ZANUSSI 0S0332

3010074 WATER SOFTENER "MATIC 8" 8 L ø 3/4"

AUTOTROL chronometric head 255/440i
230V 50Hz
time programmer mod.440 (weekly)
operating temperature 2°÷35°C
cylinder capacity 8.5 L - resin content 5.4 L
salt container 20 kg
regeneration salt(NaCl-table salt)1 Kg
inlet/outlet fittings 3/4"
dimensions: width 200 mm - depth 430 mm
height without head 335 - overall height 550 mm
We recommend to use always a mechanical filter
before the softener in order to remove
impurities from the water



ZANUSSI 0S0716

The data herewith contained may change without notice and LF SpA cannot be held responsible for possible errors stated or resulting by the use of this document. All rights reserved. No part of this publication may be reproduced without written permission by LF SpA.



LF SpA
via Voltri, 80 - 47522 Cesena (FC) ITALIA
Tel. +39 0547 34 11 11 - Fax +39 0547 34 11 10
www.lfricambi724.it - www.lfricambi724.mobi
info@lfricambi.it
Export Dept.: Tel. +39 0547 34 11 50 - Fax: +39 0547 34 11 55
www.lfspareparts724.com - www.lfspareparts724.mobi
export@lfspaceparts.com

FRANCE



EPGC Sas
13, Rue des Forts - 59960 Neuville en Ferrain
Tél. +33 (0)3 20 25 06 21
Fax +33 (0)3 20 25 34 12
www.epgc.com
www.epgc724.mobi
epgc@epgc.com

DEUTSCHLAND



LF GmbH
Junkersstrasse, 1 - D-82178 Puchheim - München
Tel. +49 89 89 45 78 66
Fax +49 89 89 45 78 88
www.lfersatzteile724.de
www.lfersatzteile724.mobi
info@lfersatzteile.de

SCHWEIZ



LF GmbH Verkaufsbüro
Sennweidstrasse, 45 - CH-6312 Steinhausen
Tel. +41 (0)41 760 15 80-1
Fax +41 (0)41 760 15 85
www.lfersatzteile724.ch
www.lfersatzteile724.mobi
info@lfersatzteile.ch

ESPAÑA



LF Repuestos Horeca S.L.U.
Calle Ciudad Real, 10 - 45517 Escalonilla - Toledo
Tif. +34 91 477 91 00
Fax +34 91 477 90 81
www.lfrepuestos724.es
www.lfrepuestos724.mobi
info@lfrepuestos.es

UNITED KINGDOM



LF Spare Parts Ltd.
A10a Lakeside Business Park, Broadway Lane
South Cerney, Gloucestershire GL7 5XL
Tel. +44 (0)1285 86 16 25
Fax +44 (0)1285 86 39 49
www.lfspareparts724.co.uk
www.lfspareparts724.mobi
info@lfspaceparts.co.uk

RUSSIA



OOO LF
ul, Anatoliya Zhivova, 8 - office 1 - 123100 Moscow
Tel. +7 499 259 85 75
Fax +7 495 725 26 53
www.lfspareparts724.ru
www.lfspareparts724.mobi
info@lfspaceparts.ru

CHINA



LF China
Room 102, House 8, Lane 725, Mao Tai Rd.
Changning Dist. - 200336 Shanghai
Tel. +86 (0)21 33 53 66 31
Fax +86 (0)21 33 53 66 32
www.lfspareparts724.com
www.lfspareparts724.mobi
china@lfspaceparts.com