



Spare parts for:

Coffee grinders



Suitable for:

NUOVA SIMONELLI



This catalogue is automatically generated.
Therefore, the sequence of the items might
not be always shown at best.
Updates will be issued in case of additions
and/or amendments.

Suitable universal spare parts may not be included





GRINDER ASSEMBLY MDS

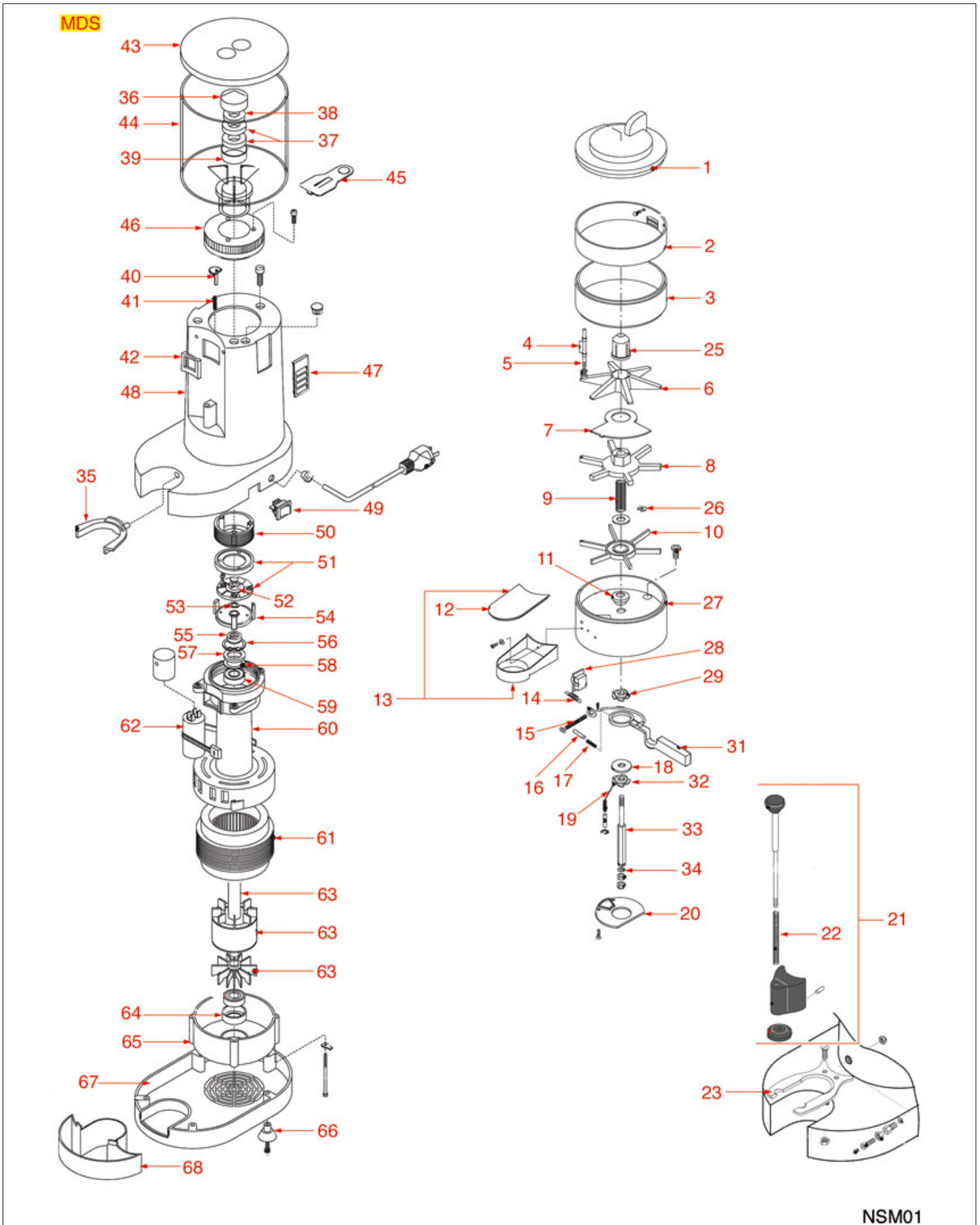

NSM01

Positions without LF code no.: upon request



NUOVA SIMONELLI



Position	LF code no.	Description
5	1324933	SPRING SHAFT SEAT
7	1252587	CLOSING SECTOR RH
11	1252590	PIN GUIDE
28	1252470	COUNTER FOR COFFEE GRINDER/DOSER
35	1252582	FILTER HOLDER FORK
46	1252583	ADJUSTMENT RING NUT
49	3319019	RED BIPOLAR SWITCH 16A 250V
49	3319934	ORANGE BIPOLAR SWITCH 16A 250V
51	1251011	GRINDING BURRS ASTRAL-ROSSI (PAIR) LEFT
55	1252378	THREADED RING NUT 15MCx1
56	1250130	SEEGER \varnothing 35 mm
58	1252376	COMPENSATION RING
59	3063005	BEARING 6202 2RS
62	3068019	CAPACITOR μ F 12.5 450V 50/60Hz



GRINDER ASSEMBLY MDSA

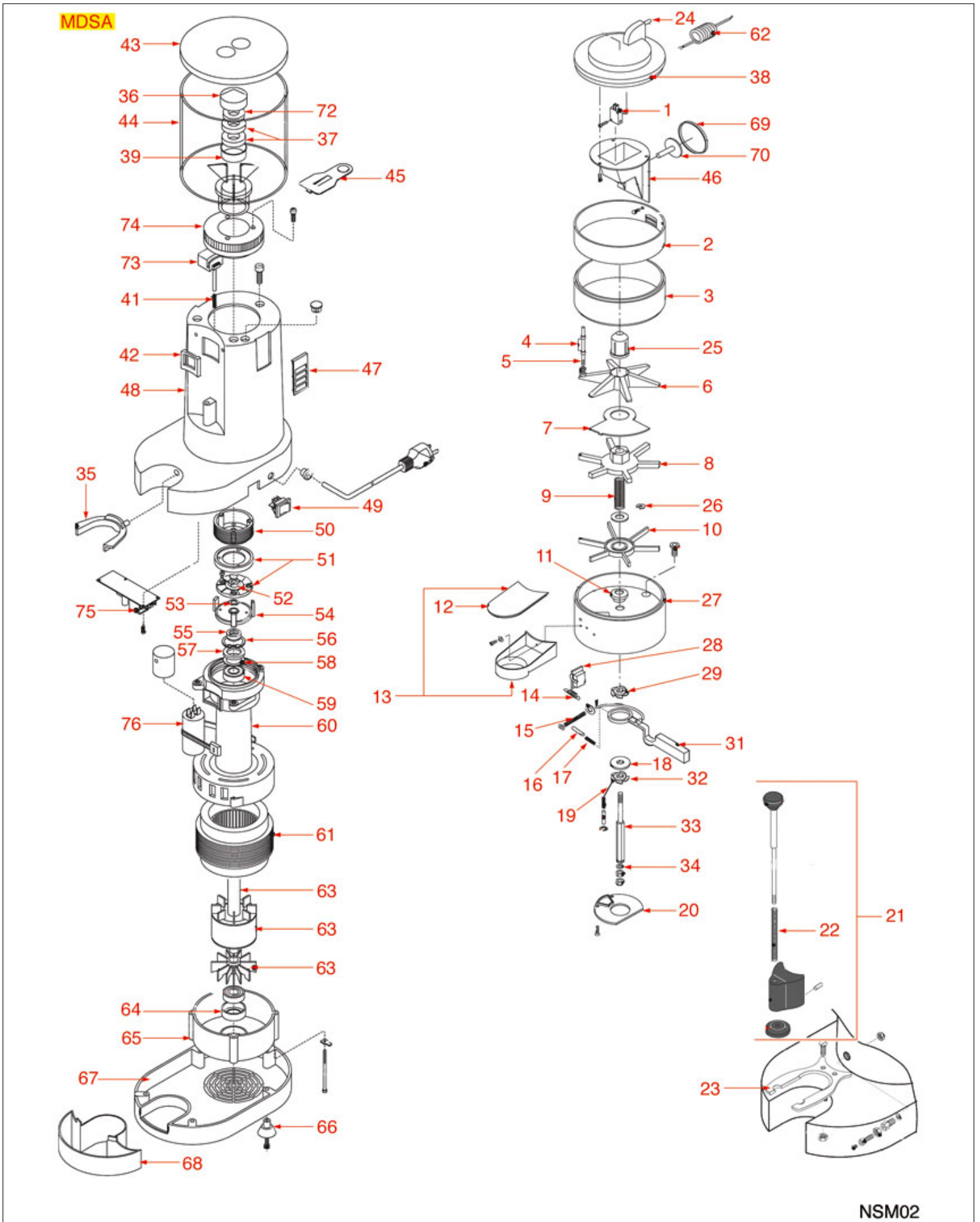

NSM02

Positions without LF code no.: upon request



NUOVA SIMONELLI



Position	LF code no.	Description
1	3240123	MICROSWITCH 16A 250V
5	1324933	SPRING SHAFT SEAT
7	1252587	CLOSING SECTOR RH
11	1252590	PIN GUIDE
28	1252470	COUNTER FOR COFFEE GRINDER/DOSER
35	1252582	FILTER HOLDER FORK
46	1252046	MICROSWITCH BOX
49	3319019	RED BIPOLAR SWITCH 16A 250V
49	3319934	ORANGE BIPOLAR SWITCH 16A 250V
51	1251011	GRINDING BURRS ASTRAL-ROSSI (PAIR) LEFT
55	1252378	THREADED RING NUT 15MCx1
56	1250130	SEEGER \varnothing 35 mm
58	1252376	COMPENSATION RING
59	3063005	BEARING 6202 2RS
76	3068019	CAPACITOR μ F 12.5 450V 50/60Hz



GRINDER ASSEMBLY MDX-MDXA

MDX - MDXA

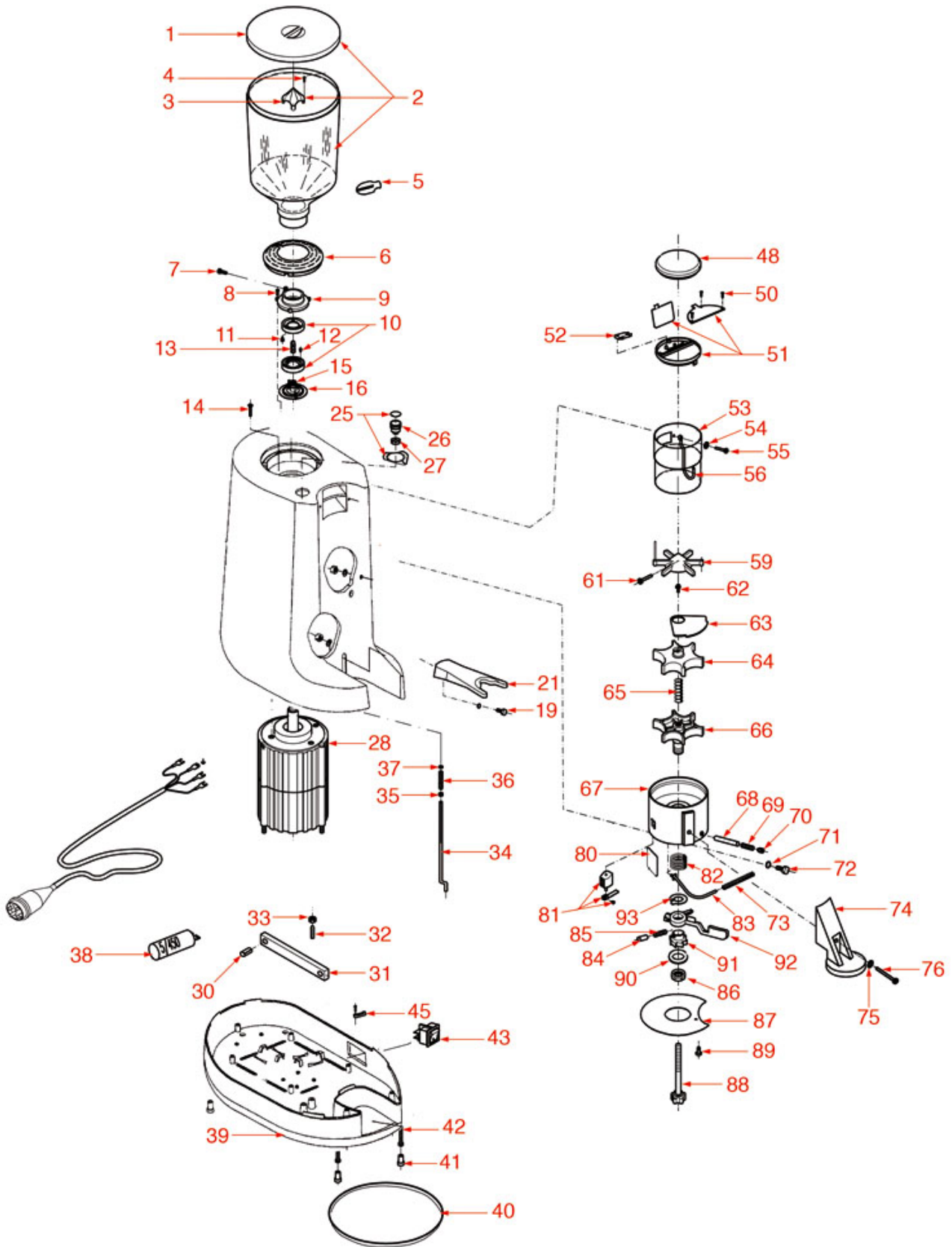

NSM03



NUOVA SIMONELLI



Position	LF code no.	Description
1	1080053	COFFEE HOPPER LID ø 180 mm
2	1080055	COMPLETE HOPPER
3	1080058	COFFEE HOPPER INNER PROTECTION
5	1080059	COFFEE CONTAINER CLOSING SHEET
6	1251064	TOP GRINDING BURRS COVER
7	1528100	CROSS HEAD SCREW M4x12 UNI 7687
9	1251065	TOP HOLDER F/GRINDING BURRS 65mm
10	1251074	GRINDING BURRS EUREKA (PAIR) RIGHT
11	3528291	CROSS HEAD FLUSH SCREW M4x8 UNI 7688
12	1528001	SCREW M4x10 UNI 6109
13	1528038	GRINDING BURRS HOLDER LOCKING NUT
15	1186504	STAINLESS STEEL WASHER ø 29x10.6x2 mm
16	1251059	GRINDING BURRS BOTTOM HOLDER
19	3528112	S/S SCREW T.E. M6x16 UNI 5739 DIN 24017
21	1162004	FILTER HOLDER PLASTIC FORK
26	1241113	ADJUSTMENT KNOB
33	1348813	HEXAGONAL NORM.NUT M4 ST.STEEL UNI 5588
35	1528030	ST.STEEL HEXAGONAL NUT M6 UNI 5588
36	1250131	TIE ROD ADJUSTMENT SPRING ø 10x60 mm
38	3068008	CAPACITOR µF 5 450V 50/60Hz
40	1252385	COFFEE COLLECTING TRAY ø 170 mm
41	1313005	FOOT ø 20 mm
43	3319294	BLACK BIPOLAR SWITCH 16A 250V
48	1252386	DOSER LID ø 125 mm
51	1252391	AUTOMATIC MICROSWITCH BOX
52	3240123	MICROSWITCH 16A 250V
53	1090002	DOSER CYLINDER ø 124/116x116 mm
59	1343034	PLASTIC TOP STAR
62	1528631	CROSS HEAD SCREW M4x8 UNI 7687
63	1343038	DIVIDING SHEET
64	1343039	CENTRAL STAR
65	1250132	STAR SPRING ø 16x60 mm
66	1343040	BOTTOM STAR
68	1252397	DOSER GROUP PIN ø 5x30 mm
69	1250087	SPRING ø 4.5x12 mm
72	3528112	S/S SCREW T.E. M6x16 UNI 5739 DIN 24017
73	1250134	DOSER LEVER RETURN SPRING 8x85 mm
74	1385012	COFFEE TAMPER ø 56 mm
81	1252398	COUNTER FOR COFFEE GRINDER RIGHTHAND
82	1250133	STAR SPRING ø 36x23 mm
84	1252396	DOSER GROUP PIN ø 5x18 mm
85	1250087	SPRING ø 4.5x12 mm
86	1528039	NUT FOR DOSER GROUP
91	1252394	DOSER PAWL
92	1225024	DOSER LEVER
93	1252395	WASHER FOR DOSER LEVER
94	1528030	ST.STEEL HEXAGONAL NUT M6 UNI 5588



GRINDER ASSEMBLY MDL-MDLCA

MDL - MDLCA

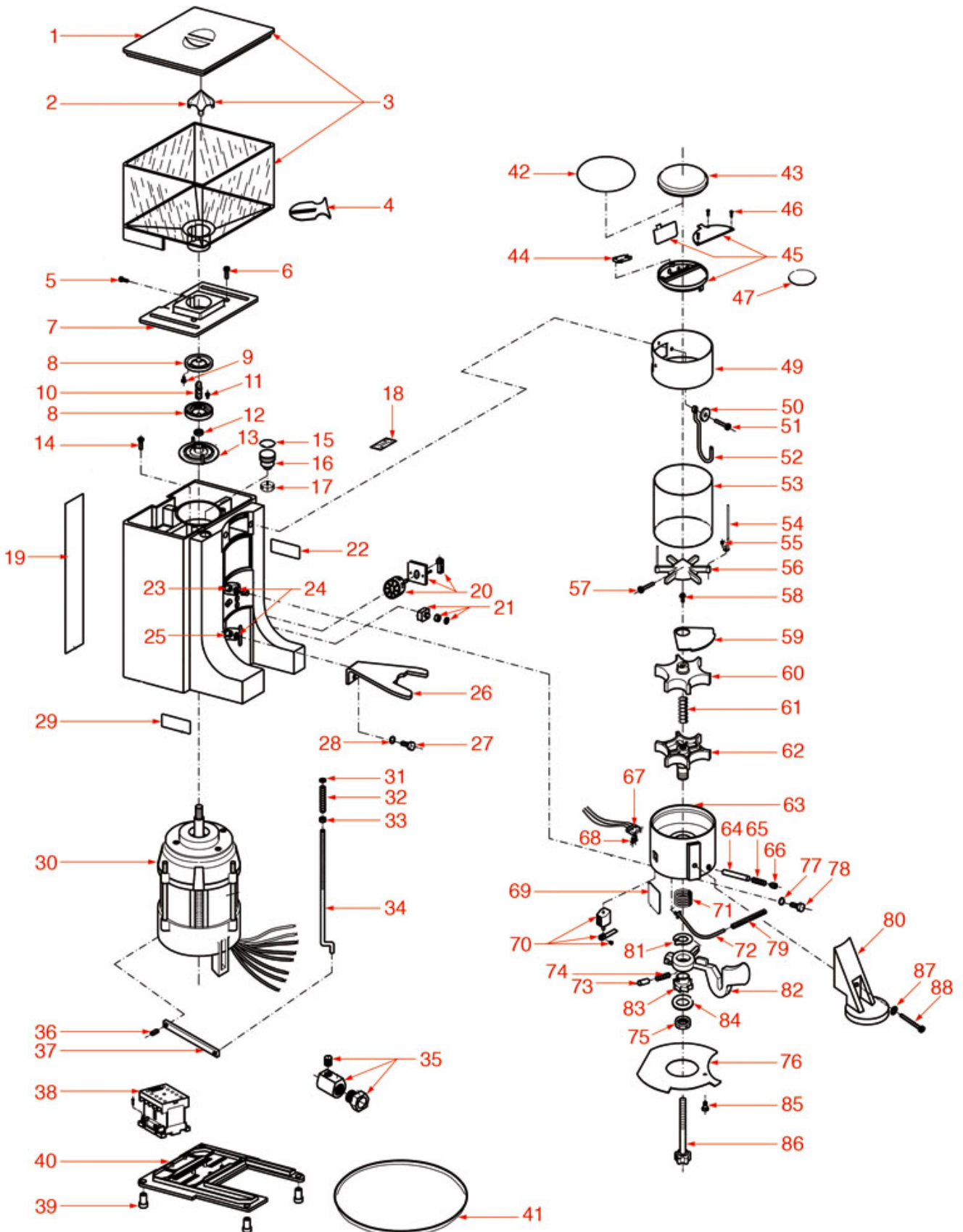

NSM04

Positions without LF code no.: upon request



NUOVA SIMONELLI



Position	LF code no.	Description
1	1080057	COFFEE HOPPER LID 168x168 mm
2	1080058	COFFEE HOPPER INNER PROTECTION
3	1080054	COMPLETE COFFEE HOPPER
4	1080059	COFFEE CONTAINER CLOSING SHEET
5	1528100	CROSS HEAD SCREW M4x12 UNI 7687
8	1251060	GRINDING BURRS EUREKA (PAIR) RIGHT
8	1251074	GRINDING BURRS EUREKA (PAIR) RIGHT
9	1528001	SCREW M4x10 UNI 6109
10	1528038	GRINDING BURRS HOLDER LOCKING NUT
11	1528001	SCREW M4x10 UNI 6109
12	1186504	STAINLESS STEEL WASHER \varnothing 29x10.6x2 mm
13	1251058	GRINDING BURRS BOTTOM HOLDER
13	1251059	GRINDING BURRS BOTTOM HOLDER
16	1241113	ADJUSTMENT KNOB
20	1057008	SELECTOR SWITCH 0-1 POSITIONS
21	1240040	PUSH-BUTTON MICROSWITCH
25	1528030	ST.STEEL HEXAGONAL NUT M6 UNI 5588
26	1252389	FILTER HOLDER FORK
27	3528112	S/S SCREW T.E. M6x16 UNI 5739 DIN 24017
32	1250131	TIE ROD ADJUSTMENT SPRING \varnothing 10x60 mm
33	1528030	ST.STEEL HEXAGONAL NUT M6 UNI 5588
41	1252385	COFFEE COLLECTING TRAY \varnothing 170 mm
43	1252386	DOSER LID \varnothing 125 mm
44	3240123	MICROSWITCH 16A 250V
45	1252391	AUTOMATIC MICROSWITCH BOX
53	1252387	DOSER CYLINDER \varnothing 117x91 mm
54	1252393	DOSER SCRAPER
56	1343034	PLASTIC TOP STAR
58	1528631	CROSS HEAD SCREW M4x8 UNI 7687
59	1252392	DIVIDING SHEET
60	1343035	ALUMINUM MIDDLE STAR
61	1250132	STAR SPRING \varnothing 16x60 mm
62	1343037	ALUMINUM BOTTOM STAR
64	1252397	DOSER GROUP PIN \varnothing 5x30 mm
65	1250087	SPRING \varnothing 4.5x12 mm
67	1240028	MICROSWITCH 6A 250V
70	1252390	COUNTER FOR COFFEE GRINDER
71	1250133	STAR SPRING \varnothing 36x23 mm
73	1252396	DOSER GROUP PIN \varnothing 5x18 mm
74	1250087	SPRING \varnothing 4.5x12 mm
75	1528039	NUT FOR DOSER GROUP
78	1528009	S/S SCREW T.E.M6x12 mm UNI 5739 DIN24017
79	1250134	DOSER LEVER RETURN SPRING 8x85 mm
80	1385012	COFFEE TAMPER \varnothing 56 mm
81	1252395	WASHER FOR DOSER LEVER
82	1225023	DOSER LEVER
83	1252394	DOSER PAWL



GRINDER ASSEMBLY MDLCA/C

MDLCA/C

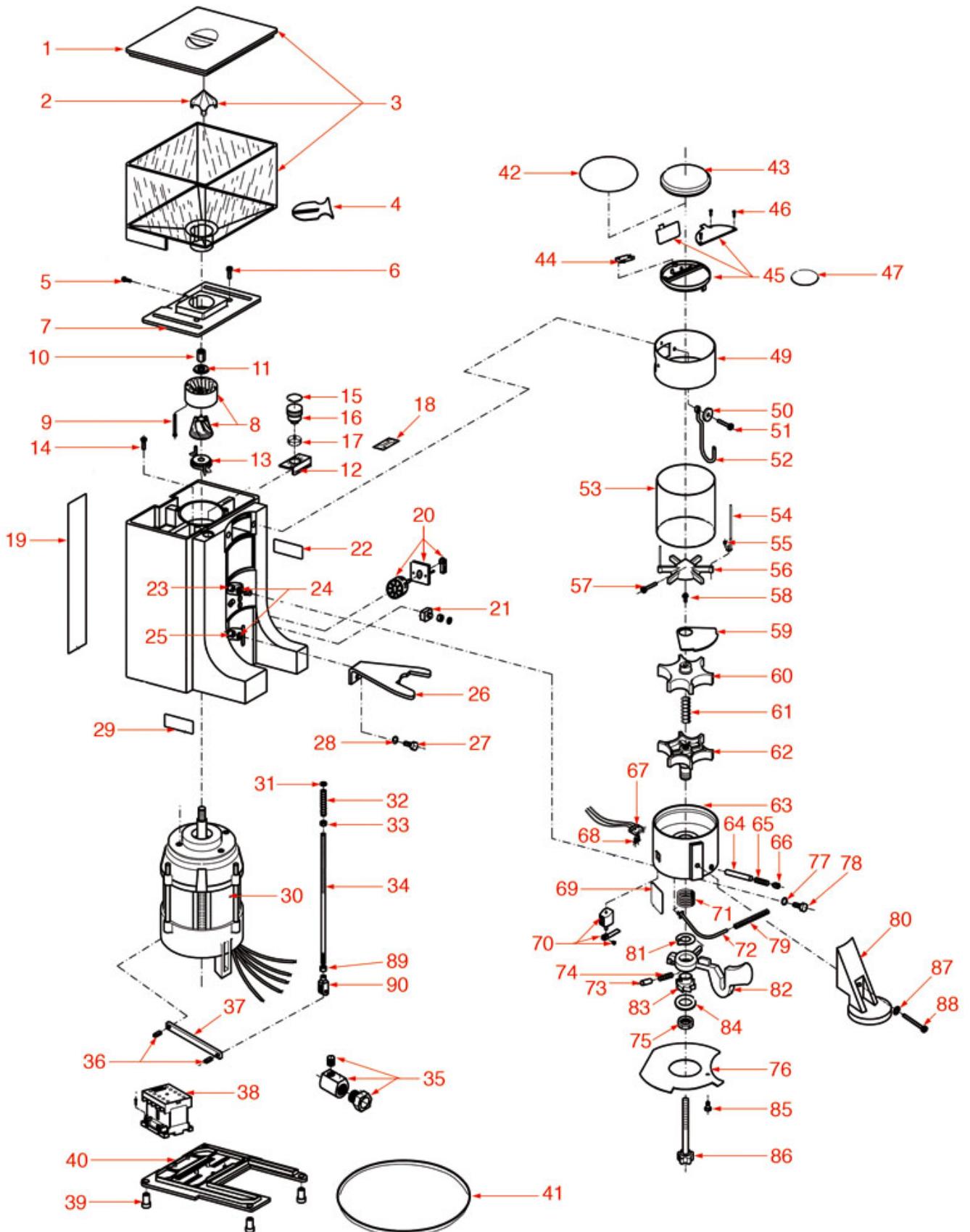



NUOVA SIMONELLI



Position	LF code no.	Description
1	1080057	COFFEE HOPPER LID 168x168 mm
2	1080058	COFFEE HOPPER INNER PROTECTION
3	1080054	COMPLETE COFFEE HOPPER
4	1080059	COFFEE CONTAINER CLOSING SHEET
5	1528100	CROSS HEAD SCREW M4x12 UNI 7687
8	1251038	CONICAL GRINDING BURRS EUREKA (PAIR) RH
16	1241113	ADJUSTMENT KNOB
20	1057008	SELECTOR SWITCH 0-1 POSITIONS
21	1240040	PUSH-BUTTON MICROSWITCH
25	1528030	ST.STEEL HEXAGONAL NUT M6 UNI 5588
26	1252389	FILTER HOLDER FORK
27	3528112	S/S SCREW T.E. M6x16 UNI 5739 DIN 24017
32	1250131	TIE ROD ADJUSTMENT SPRING \varnothing 10x60 mm
33	1528030	ST.STEEL HEXAGONAL NUT M6 UNI 5588
41	1252385	COFFEE COLLECTING TRAY \varnothing 170 mm
43	1252386	DOSER LID \varnothing 125 mm
44	3240123	MICROSWITCH 16A 250V
45	1252391	AUTOMATIC MICROSWITCH BOX
53	1252387	DOSER CYLINDER \varnothing 117x91 mm
54	1252393	DOSER SCRAPER
56	1343034	PLASTIC TOP STAR
58	1528631	CROSS HEAD SCREW M4x8 UNI 7687
59	1252392	DIVIDING SHEET
60	1343035	ALUMINUM MIDDLE STAR
61	1250132	STAR SPRING \varnothing 16x60 mm
62	1343037	ALUMINUM BOTTOM STAR
64	1252397	DOSER GROUP PIN \varnothing 5x30 mm
65	1250087	SPRING \varnothing 4.5x12 mm
67	1240028	MICROSWITCH 6A 250V
70	1252390	COUNTER FOR COFFEE GRINDER
71	1250133	STAR SPRING \varnothing 36x23 mm
73	1252396	DOSER GROUP PIN \varnothing 5x18 mm
74	1250087	SPRING \varnothing 4.5x12 mm
75	1528039	NUT FOR DOSER GROUP
78	1528009	S/S SCREW T.E.M6x12 mm UNI 5739 DIN24017
79	1250134	DOSER LEVER RETURN SPRING 8x85 mm
80	1385012	COFFEE TAMPER \varnothing 56 mm
81	1252395	WASHER FOR DOSER LEVER
82	1225023	DOSER LEVER
83	1252394	DOSER PAWL



GRINDER ASSEMBLY MCF

MCF

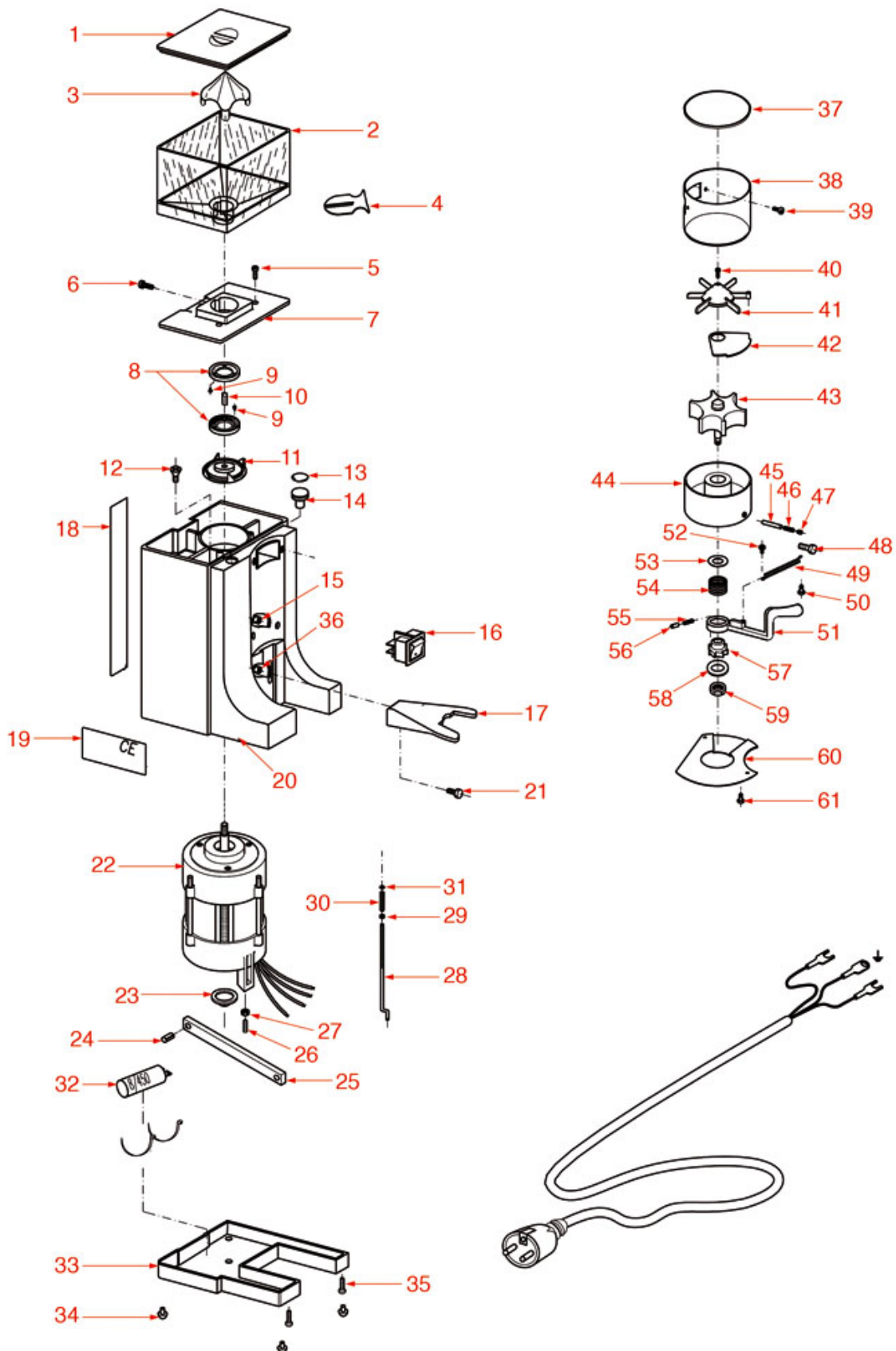

NSM06



NUOVA SIMONELLI



Position	LF code no.	Description
1	1080061	COFFEE HOPPER LID 107x107 mm
2	1080056	COFFEE HOPPER
3	1080058	COFFEE HOPPER INNER PROTECTION
4	1080060	STAINL.STEEL COFFEE CONT.CLOSING SHEET
5	1528100	CROSS HEAD SCREW M4x12 UNI 7687
6	1528100	CROSS HEAD SCREW M4x12 UNI 7687
8	1251069	GRINDING BURRS EUREKA (PAIR) RIGHT
9	1528042	SCREW M3x6 WITH CUT HEAD
16	3319294	BLACK BIPOLAR SWITCH 16A 250V
27	1528030	ST.STEEL HEXAGONAL NUT M6 UNI 5588
32	3068014	CAPACITOR μ F 8 450V 50/60Hz
36	1528030	ST.STEEL HEXAGONAL NUT M6 UNI 5588
37	1090005	HOPPER LID \varnothing 95 mm
38	1090004	DOSER CYLINDER \varnothing 95x60 mm
39	3528291	CROSS HEAD FLUSH SCREW M4x8 UNI 7688
41	1343044	TOP STAR
42	1343045	S/STEEL DIVIDING SHEET
43	1343050	BOTTOM STAR
45	1252399	DOSE GROUP PIN \varnothing 4x18 mm
46	1250135	DOSER CLASP SPRING \varnothing 4x18 mm
49	1250136	DOSER LEVER RETURN SPRING 4x48 mm
51	1225025	DOSER LEVER
54	1250137	STAR SPRING \varnothing 24x24 mm
55	1250138	PIN SPRING \varnothing 4x12 mm
56	1252400	DOSE GROUP PIN \varnothing 4x16 mm
57	1252402	PAWL 5 TEETH



Suitable for:

Suitable for:

Bearings

3063005 BEARING 6202 2RS
external \varnothing 35 mm -internal \varnothing 15 mm-thickness 11 mm



NUOVA SIMONELLI 15010034

NUOVA SIMONELLI 15100086

Bodies

1251064 TOP GRINDING BURRS COVER
for Grinder-dispenser (EUREKA) LUSSO MDML
MONDIAL MDMC - MONDIAL MDME
for Grinder-dispenser (NUOVA SIMONELLI) MDX - MDXA



NUOVA SIMONELLI 15050010

Capacitors

3068016 CAPACITOR μ F 10 450V 50/60Hz
operating temperature $-25+85^{\circ}\text{C}$
in compliance with EEC 93/68 and 92/31 regulations



NUOVA SIMONELLI 04000043

NUOVA SIMONELLI 15050009

3068019 CAPACITOR μ F 12.5 450V 50/60Hz
operating temperature $-25+85^{\circ}\text{C}$
in compliance with EEC 93/68 and 92/31 regulations



NUOVA SIMONELLI 15010033

3068024 CAPACITOR μ F 16 450V 50/60Hz
operating temperature $-25+85^{\circ}\text{C}$
in compliance with EEC 93/68 and 92/31 regulations



NUOVA SIMONELLI 15050002

NUOVA SIMONELLI 15050023

3068008 CAPACITOR μ F 5 450V 50/60Hz
operating temperature $-25+85^{\circ}\text{C}$
in compliance with EEC 93/68 and EEC 92/31 regulat



NUOVA SIMONELLI



Suitable for:

3068010 CAPACITOR μ F 6.3 450V 50/60Hz
operating temperature -25+85°C
in compliance with EEC 93/68 and EEC 92/31 regulat



NUOVA SIMONELLI 04000010

Suitable for:

3068014 CAPACITOR μ F 8 450V 50/60Hz
operating temperature -25+85°C
in compliance with EEC 93/68 and 92/31 regulations

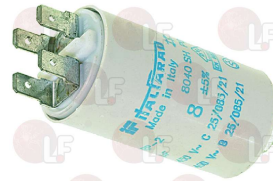

NUOVA SIMONELLI

Circlips

1250130 SEEGER \varnothing 35 mm
for Grinder-dispenser (ROSSI) RR45



NUOVA SIMONELLI 15010037

1348817 STAINLESS STEEL CIRCLIP RA-4 UNI 7437



NUOVA SIMONELLI

Containers for coffee

1080059 COFFEE CONTAINER CLOSING SHEET
for Coffee grinder (CASADIO) Istantaneo
for Grinder-dispenser (CASADIO) GC98 - G84
MOKABIX
for Grinder-dispenser (EUREKA) LUSO MDLC
LUSO MDLCA/C - LUSO MDLCA65 - LUSO MDML
MDMEA
for Grinder-dispenser (NUOVA SIMONELLI) MDL
MDLCA - MDLCA/C - MDX - MDXA



NUOVA SIMONELLI 15000040

1080056 COFFEE HOPPER
for Grinder-dispenser (EUREKA) MCF
for Grinder-dispenser (NUOVA SIMONELLI) MCF



NUOVA SIMONELLI 15800002

1080917 COFFEE HOPPER
for Grinder-dispenser (BRASILIA) MC - RR45 - RR55
RR65 - R80
for Grinder-dispenser (NUOVA SIMONELLI) MDS - MDSA
for Grinder-dispenser (ROSSI) MC - RR45 - RR55
RR65 - R80



NUOVA SIMONELLI 15010002

1080058 COFFEE HOPPER INNER PROTECTION



NUOVA SIMONELLI 15050011



NUOVA SIMONELLI



Suitable for:

1080053 COFFEE HOPPER LID ø 180 mm
for Grinder-dispenser (EUREKA) MONDIAL MDMC
MONDIAL MDME
for Grinder-dispenser (NUOVA SIMONELLI) MDX - MDXA

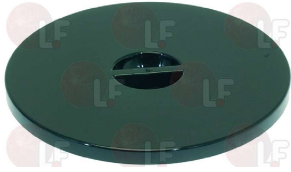

NUOVA SIMONELLI 15000055

Suitable for:

1080061 COFFEE HOPPER LID 107x107 mm
for Grinder-dispenser (EUREKA) MCF
for Grinder-dispenser (NUOVA RICAMBI) MCF

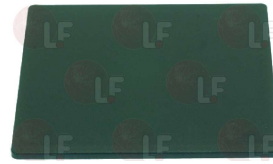

NUOVA SIMONELLI 15800001

1080057 COFFEE HOPPER LID 168x168 mm
for Grinder-dispenser (EUREKA) LUSO MDLCA65
LUSO MDLCA75
for Grinder-dispenser (NUOVA SIMONELLI) MDL
MDLCA - MDLCA/C



NUOVA SIMONELLI 15000050

1080054 COMPLETE COFFEE HOPPER
for Grinder-dispenser (CASADIO) GC98 - G84
for Grinder-dispenser (EUREKA) MDLCA/C - MDLCA75
for Grinder-dispenser (NUOVA SIMONELLI) MDL
MDLCA - MDLCA/C



NUOVA SIMONELLI 15000051

1080055 COMPLETE HOPPER
for Grinder-dispenser (EUREKA) MDMCA - MDMEA
for Grinder-dispenser (NUOVA SIMONELLI) MDX - MDXA



NUOVA SIMONELLI 15000056

1080060 STAINL.STEEL COFFEE CONT.CLOSING SHEET
for Grinder-dispenser (EUREKA) MCF
for Grinder-dispenser (NUOVA SIMONELLI) MCF



NUOVA SIMONELLI 15800042

Counters

1252390 COUNTER FOR COFFEE GRINDER
for Grinder-dispenser (EUREKA) LUSO MDLCA/C
LUSO MDLCA65 - LUSO MDLCA75 - LUSO MDML
MONDIAL MDMC
for Grinder-dispenser (NUOVA SIMONELLI) MDL
MDLCA - MDLCA/C



NUOVA SIMONELLI 15000071

1252398 COUNTER FOR COFFEE GRINDER RIGHTHAND
for Grinder-dispenser (EUREKA) MDMEA
for Grinder-dispenser (NUOVA SIMONELLI) MDX - MDXA



NUOVA SIMONELLI 15000031

1252470 COUNTER FOR COFFEE GRINDER/DOSER
for Grinder-dispenser (SAN MARCO) SMFK - SMMK
SM90 - SM91 - SM92 - SM95 - SM96



NUOVA SIMONELLI 15010063

Dosers for coffee

1252387 DOSER CYLINDER ø 117x91 mm
for Grinder-dispenser (EUREKA) LUSO MDLCA/C
LUSO MDLCA65 - LUSO MDLCA75
for Grinder-dispenser (NUOVA SIMONELLI) MDL
MDLCA - MDLCA/C



NUOVA SIMONELLI 15000036

1090002 DOSER CYLINDER ø 124/116x116 mm
ø external 124/116 mm - height 116 mm
for Grinder-dispenser (EUREKA) MDMEA
for Grinder-dispenser (NUOVA SIMONELLI) MDX - MDXA



NUOVA SIMONELLI 15000022

1090004 DOSER CYLINDER ø 95x60 mm
for Grinder-dispenser (EUREKA) MCF
for Grinder-dispenser (NUOVA SIMONELLI) MCF



NUOVA SIMONELLI 15800015

1252386 DOSER LID ø 125 mm
for Coffee grinder (EUREKA) MDL - MDX - MDXA
for Grinder-dispenser (EUREKA) LUSO MDLCA/C
LUSO MDLCA65 - LUSO MDLCA75 - LUSO MDML
MDLCA - MDLCA/C - MONDIAL MDMC - MONDIAL MDME



NUOVA SIMONELLI 15080005

1252393 DOSER SCRAPER
for Grinder-dispenser (EUREKA) LUSO MDLCA/C
LUSO MDLCA65 - LUSO MDLCA75 - LUSO MDML
MONDIAL MDMC
for Grinder-dispenser (NUOVA SIMONELLI) MDL
MDLCA - MDLCA/C



NUOVA SIMONELLI

1090005 HOPPER LID ø 95 mm
for Grinder-dispenser (EUREKA) MCF
for Grinder-dispenser (NUOVA SIMONELLI) MCF

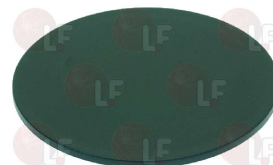

NUOVA SIMONELLI 15800014



Suitable for:

Suitable for:

1324933 SPRING SHAFT SEAT



NUOVA SIMONELLI 15010006

Feet

1313005 FOOT ø 20 mm



NUOVA SIMONELLI 15050013

Forks for portafilter coffee grinder

1252389 FILTER HOLDER FORK

for Grinder-dispenser (ANFIM) LUSSO MDLCA/C
LUSSO MDLCA65 - LUSSO MDLC75 - LUSSO MDML
MONDIAL MDMC
for Grinder-dispenser (NUOVA SIMONELLI) MDL
MDLCA - MDLCA/C



NUOVA SIMONELLI 15000009

1252582 FILTER HOLDER FORK

for Grinder-dispenser (BRASILIA) RR45 - R80
for Grinder-dispenser (NUOVA SIMONELLI) MDS - MDSA
for Grinder-dispenser (ROSSI) RR45 - R80



NUOVA SIMONELLI 15010016

1162004 FILTER HOLDER PLASTIC FORK

for Grinder-dispenser (EUREKA) MONDIAL MDME
for Grinder-dispenser (NUOVA SIMONELLI) MDX - MDXA



NUOVA SIMONELLI 15000057

Gaskets and seals

1186397 O RING GASKET OR 02300 EPDM

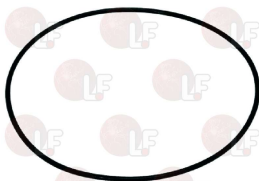

NUOVA SIMONELLI 02280033

1186763 O-RING 0171 EPDM



NUOVA SIMONELLI 40200010

Suitable for:

1186421 O-RING 02018 EPDM



NUOVA SIMONELLI 18010555

Suitable for:

1186223 O-RING 02056 EPDM



NUOVA SIMONELLI 0228032

Gears

1212011 PLANETARY GEAR
for Grinder-dispenser (BRASILIA) MC
for Grinder-dispenser (ROSSI) MC



NUOVA SIMONELLI 15020015

1212010 REDUCTION GEAR FOR CAFFEE GRINDER
for Grinder-dispenser (BRASILIA) MC
for Grinder-dispenser (ROSSI) MC



NUOVA SIMONELLI 15020013

Grinders

1251038 CONICAL GRINDING BURRS EUREKA (PAIR) RH
external \varnothing 68/49 mm - internal \varnothing 45/13 mm
thickness 25 mm - 4 fixing holes
for Grinder-dispenser (EUREKA) LUSO MDLCA/C
for Grinder-dispenser (NUOVA SIMONELLI) MDLCA/C



NUOVA SIMONELLI 15070001

1251076 CONICAL GRINDING BURRS ROSSI (PAIR) RH
external \varnothing 68/49 mm - internal \varnothing 41/13 mm
thickness 25 mm - 4 mounting holes
inner groove for feather
for Grinder-dispenser (BRASILIA) MC
for Grinder-dispenser (CASADIO) GC98
for Grinder-dispenser (MACAP) M7K - M7KA - M7KT
for Grinder-dispenser (OBEL) MITOCONIC
for Grinder-dispenser (ROSSI) MC



NUOVA SIMONELLI 15020001

1251011 GRINDING BURRS ASTRAL-ROSSI (PAIR) LEFT
external \varnothing 64 mm - internal \varnothing 38 mm
thickness 9 mm - 3 fixing holes
for Grinder-dispenser (BRASILIA) CC45 - RR45
RR55 - RR65 - R80
for Grinder-dispenser (FIAMMA RST) MCF4 - MCF7
for Grinder-dispenser (NUOVA SIMONELLI) MDS - MDSA
for Grinder-dispenser (ROSSI) CC45 - RR45 - RR55
RR65 - R80



NUOVA SIMONELLI 15010030

1251060 GRINDING BURRS EUREKA (PAIR) RIGHT
external \varnothing 74 mm - internal \varnothing 38 mm
thickness 9 mm - 3 mounting holes
for EUREKA LUSO MDLCA75-LUSO MDML
for NUOVA SIMONELLI MDL-MDLCA
for NUOVA SIMONELLI SUPERAUTOMATICA CAFFETTERIA
ITALIANA
for Grinder-dispenser (EUREKA) LUSO MDLCA75
LUSO MDML
for Grinder-dispenser (NUOVA SIMONELLI) MDL
MDLCA



NUOVA SIMONELLI 15080002



Suitable for:

1251069 GRINDING BURRS EUREKA (PAIR) RIGHT
 ø external 50 mm - ø internal 30 mm
 thickness 8 mm - 3 mounting holes
 for Grinder-dispenser (EUREKA) MCF
 for Grinder-dispenser (NUOVA SIMONELLI) MCF



NUOVA SIMONELLI 15800039

NUOVA SIMONELLI 15800045

Suitable for:

1251074 GRINDING BURRS EUREKA (PAIR) RIGHT
 external ø 64 mm - internal ø 38 mm
 thickness 9 mm - 3 mounting holes
 for Grinder-dispenser (EUREKA) MDLCA - MDMCA
 for Grinder-dispenser (NUOVA SIMONELLI) MDX - MDXA



NUOVA SIMONELLI 15050001

Grinding burr holders

1252583 ADJUSTMENT RING NUT
 for Grinder-dispenser (BRASILIA) CC45 - RR55
 RR65 - R80
 for Grinder-dispenser (NUOVA SIMONELLI) MDS
 for Grinder-dispenser (ROSSI) CC45 - RR55 - RR65
 R80

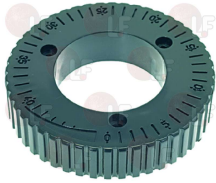

NUOVA SIMONELLI 15010028

1251058 GRINDING BURRS BOTTOM HOLDER
 for Grinder-dispenser (EUREKA) LUSSO MDLC75
 LUSSO MDML
 for Grinder-dispenser (NUOVA SIMONELLI) MDL
 MDLCA



NUOVA SIMONELLI 15080009

1251059 GRINDING BURRS BOTTOM HOLDER
 for Grinder-dispenser (EUREKA) LUSSO MDLCA65
 MONDIAL MDMC - MONDIAL MDME
 for Grinder-dispenser (NUOVA SIMONELLI) MDLCA
 MDXA

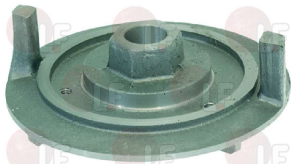

NUOVA SIMONELLI 15000043

1528038 GRINDING BURRS HOLDER LOCKING NUT
 for Grinder-dispenser (EUREKA) LUSSO MDLCA65
 LUSSO MDLC75 - LUSSO MDML
 for Grinder-dispenser (NUOVA SIMONELLI) MDL
 MDLCA - MDX - MDXA

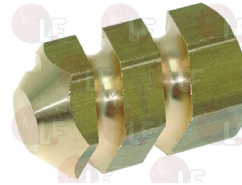

NUOVA SIMONELLI 15000064

1252378 THREADED RING NUT 15MCx1
 for Grinder-dispenser (BRASILIA) MAC64
 for Grinder-dispenser (NUOVA SIMONELLI) MDS - MDSA
 for Grinder-dispenser (ROSSI) MAC64 - RR45
 RR550D



NUOVA SIMONELLI 15010079

1251065 TOP HOLDER F/GRINDING BURRS 65mm
 for Grinder-dispenser (EUREKA) MDMCA
 for Grinder-dispenser (NUOVA SIMONELLI) MDX - MDXA



NUOVA SIMONELLI 15000044

Ironmongery (screws,nuts,washers)

1252376 COMPENSATION RING
for Grinder-dispenser (BRASILIA) RR45
for Grinder-dispenser (ROSSI) RR45



NUOVA SIMONELLI 15010035

3528291 CROSS HEAD FLUSH SCREW M4x8 UNI 7688



NUOVA SIMONELLI

1528100 CROSS HEAD SCREW M4x12 UNI 7687



NUOVA SIMONELLI

1528631 CROSS HEAD SCREW M4x8 UNI 7687



NUOVA SIMONELLI

1348813 HEXAGONAL NORM.NUT M4 ST.STEEL UNI 5588



NUOVA SIMONELLI

3528213 HEXAGONAL NORMAL NUT M5 UNI 5588



NUOVA SIMONELLI 00000003

1528039 NUT FOR DOSER GROUP



NUOVA SIMONELLI 15050017

3528112 S/S SCREW T.E. M6x16 UNI 5739 DIN 24017

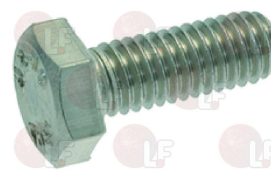

NUOVA SIMONELLI

1528009 S/S SCREW T.E.M6x12 mm UNI 5739 DIN24017



NUOVA SIMONELLI

1348814 S/STEEL COGGED WASHER M4 UNI 8842



NUOVA SIMONELLI 00000011

NUOVA SIMONELLI 18010291

1528049 S/STEEL SCREW T.C.C.E.I. M4x16 UNI 5931



NUOVA SIMONELLI 00000148

1528627 S/STEEL SCREW T.S.P.C.E.I.M8x20 UNI 5933



NUOVA SIMONELLI



Suitable for:

1528042 SCREW M3x6 WITH CUT HEAD



NUOVA SIMONELLI 00000134

Suitable for:

1528001 SCREW M4x10 UNI 6109



NUOVA SIMONELLI

1528030 ST. STEEL HEXAGONAL NUT M6 UNI 5588



NUOVA SIMONELLI

1186504 STAINLESS STEEL WASHER ø 29x10.6x2 mm



NUOVA SIMONELLI LF-1528010

1252395 WASHER FOR DOSER LEVER



NUOVA SIMONELLI 15050019

1528643 WASTE DRAWER LOCKING SCREW M6x20 UNI5923



NUOVA SIMONELLI 00200013

Knobs

1241113 ADJUSTMENT KNOB



NUOVA SIMONELLI 15000042

Levers

1225023 DOSER LEVER

for Grinder-dispenser (EUREKA) LUSO MDLCA/C
LUSO MDLCA65 - LUSO MDLC75 - LUSO MDML
MONDIAL MDMC
for Grinder-dispenser (NUOVA SIMONELLI) MDL
MDLCA - MDLCA/C



NUOVA SIMONELLI 15050022

1225024 DOSER LEVER

for Grinder-dispenser (EUREKA) MDMEA
for Grinder-dispenser (NUOVA SIMONELLI) MDX - MDXA



NUOVA SIMONELLI 15000028

Suitable for:

Suitable for:

- 1225025 DOSER LEVER**
 for Grinder-dispenser (EUREKA) MCF
 for Grinder-dispenser (NUOVA SIMONELLI) MCF



NUOVA SIMONELLI 15800027

Microswitches

- 1252391 AUTOMATIC MICROSWITCH BOX**
 without microswitch
 for Grinder-dispenser (EUREKA) LUSO MDLCA/C
 LUSO MDLCA65 - LUSO MDLCA75 - MONDIAL MDMC
 MONDIAL MDME
 for Grinder-dispenser (NUOVA SIMONELLI) MDL
 MDLCA - MDLCA/C - MDX - MDXA



NUOVA SIMONELLI 15050012

- 1252046 MICROSWITCH BOX**



NUOVA SIMONELLI 15010094

- 3240123 MICROSWITCH 16A 250V**



NUOVA SIMONELLI 15000041

NUOVA SIMONELLI 15020003

- 1240028 MICROSWITCH 6A 250V**
 for Grinder-dispenser (EUREKA) LUSO MDLCA/C
 LUSO MDLCA65 - LUSO MDLCA75 - LUSO MDML
 MONDIAL MDMC
 for Grinder-dispenser (NUOVA SIMONELLI) MDL
 MDLCA - MDLCA/C

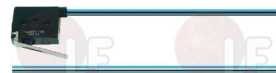

NUOVA SIMONELLI 15100088

- 1240040 PUSH-BUTTON MICROSWITCH**
 for Grinder-dispenser (EUREKA) LUSO MDLCA/C
 LUSO MDLCA65 - LUSO MDLCA75 - LUSO MDML
 MONDIAL MDMC
 for Grinder-dispenser (NUOVA SIMONELLI) MDL
 MDLCA - MDLCA/C



NUOVA SIMONELLI 15000070



Suitable for:

Suitable for:

Pawls for coffee grinder dosers

1252394 DOSER PAWL



NUOVA SIMONELLI 15000027

1252402 PAWL 5 TEETH
for Grinder-dispenser (EUREKA) MCF
for Grinder-dispenser (NUOVA SIMONELLI) MCF



NUOVA SIMONELLI 15800028

Pins

1252400 DOSE GROUP PIN \varnothing 4x16 mm



NUOVA SIMONELLI 15800021

1252399 DOSE GROUP PIN \varnothing 4x18 mm



NUOVA SIMONELLI 15800040

1252396 DOSER GROUP PIN \varnothing 5x18 mm

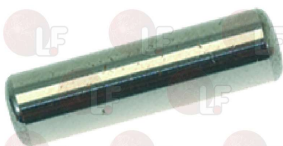

NUOVA SIMONELLI 15050016

1252397 DOSER GROUP PIN \varnothing 5x30 mm



NUOVA SIMONELLI 15050015

Pull-through brushes

1384001 BRUSH FOR COFFEE SHOWER



NUOVA SIMONELLI 05080012

Relays

3351154 BASE OCTAL ES8 10A 400V
8 poles

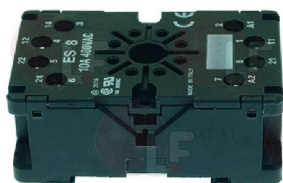

NUOVA SIMONELLI 09000011

3351007 MINI RELAY 55.32 10A 240V 50/60Hz
2 switching contacts
manual push-button
for PIZZA SHAPER PF45MTE

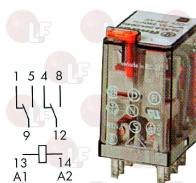

NUOVA SIMONELLI 15010055

Suitable for:

Suitable for:

3351032 POWER RELAY 66.82 30A 250V
 for LC80-LC140-LC1000-LC1500-LC1700-LC2000
 LC2300-LC2300TR-LC2600-LC2800
 for mod. till 06/12
 for FIORENZATO MC F5-F6
 for RENEKA VIVAE-VIVAS-VIVA-LC-XL-PLUS-PRESTIGE
 MOSAIC
 for NUOVA SIMONELLI APPIACOMPACT

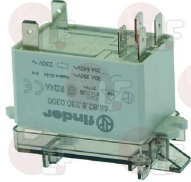

NUOVA SIMONELLI 04200007

Remote control switches

3446561 CONTACTOR LOVATO BF0910A
 coil 9A 230V 50/60Hz 4.2Kw
 3 normally open contacts
 1 normally open auxiliary contact

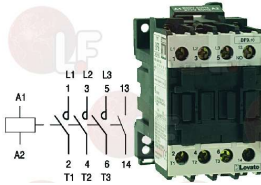

NUOVA SIMONELLI 04200019

Rotary switches

1057008 SELECTOR SWITCH 0-1 POSITIONS
 for Grinder-dispenser (EUREKA) LUSSO MDLCA/C
 LUSSO MDLCA65 - LUSSO MDLC75 - LUSSO MDML
 MONDIAL MDMC
 for Grinder-dispenser (NUOVA SIMONELLI) MDL
 MDLCA - MDLCA/C



NUOVA SIMONELLI 15070003

Springs

1250135 DOSER CLASP SPRING \varnothing 4x18 mm

1250136 DOSER LEVER RETURN SPRING 4x48 mm
 for EUREKA MCF
 for NUOVA SIMONELLI MCF



NUOVA SIMONELLI 15800041

NUOVA SIMONELLI 15800024



Suitable for:

Suitable for:

1250134 DOSER LEVER RETURN SPRING 8x85 mm
 for EUREKA MDLCA65-MDLCA75-MDLCA/C-MDML
 MONDIAL MDMC-MONDIAL MDME
 for NUOVA SIMONELLI MDX-MDXA-MDL-MDLCA-MDLCA/C

1250138 PIN SPRING \varnothing 4x12 mm

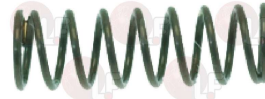

NUOVA SIMONELLI 15000033

NUOVA SIMONELLI 15800026

1250087 SPRING \varnothing 4.5x12 mm

1250132 STAR SPRING \varnothing 16x60 mm
 for EUREKA LUSSO MDLCA65-MDLCA75-LUSSO MDLCA/C
 LUSSO MDML-MONDIAL MDMC-MONDIAL MDME
 for NUOVA SIMONELLI MDX-MDXA-MDL-MDLCA-MDLCA/C



NUOVA SIMONELLI 15050014

NUOVA SIMONELLI 15000062

1250137 STAR SPRING \varnothing 24x24 mm
 for EUREKA MCF
 for NUOVA SIMONELLI MCF

1250133 STAR SPRING \varnothing 36x23 mm
 for EUREKA LUSSO MDLCA65/MDLC75-LUSSO MDLCA/C
 LUSSO MDML-MONDIAL MDMC-MONDIAL MDME
 for NUOVA SIMONELLI MDX-MDXA-MDL-MDLCA-MDLCA/C



NUOVA SIMONELLI 15800023

NUOVA SIMONELLI 15000060

1250131 TIE ROD ADJUSTMENT SPRING \varnothing 10x60 mm



NUOVA SIMONELLI

Stars and spare parts

1343037 ALUMINUM BOTTOM STAR
 for Grinder-dispenser (EUREKA) LUSSO MDLCA/C
 LUSSO MDLCA65 - LUSSO MDLC75 - LUSSO MDML
 MONDIAL MDMC
 for Grinder-dispenser (NUOVA SIMONELLI) MDLCA
 MDLCA/C

1343035 ALUMINUM MIDDLE STAR
 for Grinder-dispenser (EUREKA) LUSSO MDLCA/C
 LUSSO MDLCA65 - LUSSO MDLC75 - LUSSO MDML
 MONDIAL MDMC
 for Grinder-dispenser (NUOVA SIMONELLI) MDL
 MDLCA - MDLCA/C



NUOVA SIMONELLI 15000073

NUOVA SIMONELLI

Suitable for:

1343040 BOTTOM STAR
for Grinder-dispenser (EUREKA) MDMEA
for Grinder-dispenser (NUOVA SIMONELLI) MDX - MDXA



NUOVA SIMONELLI 15000025

Suitable for:

1343050 BOTTOM STAR
for Grinder-dispenser (EUREKA) MCF
for Grinder-dispenser (NUOVA SIMONELLI) MCF



NUOVA SIMONELLI 15800018

1343039 CENTRAL STAR
for Grinder-dispenser (EUREKA) MDMEA
for Grinder-dispenser (NUOVA SIMONELLI) MDX - MDXA



NUOVA SIMONELLI 15000024

1252587 CLOSING SECTOR RH



NUOVA SIMONELLI 15010015

1252392 DIVIDING SHEET



NUOVA SIMONELLI 15000084

1343038 DIVIDING SHEET
for Grinder-dispenser (EUREKA) MDMEA
for Grinder-dispenser (NUOVA SIMONELLI) MDX - MDXA



NUOVA SIMONELLI 15000023

1252590 PIN GUIDE



NUOVA SIMONELLI 15010085

1343034 PLASTIC TOP STAR
for Grinder-dispenser (EUREKA) LUSSO MDLCA/C
LUSSO MDLCA65 - LUSSO MDLC75 - LUSSO MDML
MONDIAL MDMC - MONDIAL MDME
for Grinder-dispenser (NUOVA SIMONELLI) MDL
MDLCA/C - MDX - MDXA



NUOVA SIMONELLI 15000026

1343045 S/STEEL DIVIDING SHEET
for Grinder-dispenser (EUREKA) MCF
for Grinder-dispenser (NUOVA SIMONELLI) MCF

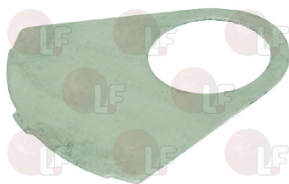

NUOVA SIMONELLI 15800017

1343044 TOP STAR
for Grinder-dispenser (EUREKA) MCF
for Grinder-dispenser (NUOVA SIMONELLI) MCF



NUOVA SIMONELLI 15800016



Suitable for:

NUOVA SIMONELLI



Suitable for:

Switches

3319154 BLACK BIPOLAR SWITCH 16A 250V
with push-button cover
0-1 silk-screen printing
max temperature 120°C
mounting hole 22x30 mm
for Coffee grinder (ASTORIA CMA) K30

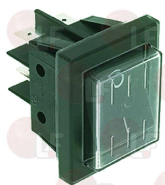

NUOVA SIMONELLI 16200027

NUOVA SIMONELLI 16300119

3319294 BLACK BIPOLAR SWITCH 16A 250V
with red led indicator light
mounting hole 30x22 mm



NUOVA SIMONELLI 15000058

3319468 BLACK SINGLE POLE SWITCH 16A 250V
silk-screen printing 0 - I
max temperature 120°C
mounting hole 11x30 mm
for CAB FAST COLD 1-2-3/NEW FABY 1-2-3
for COFRIMELL FRIGO DRINK COF-COLDREAM-JETCOF-
MEGA25-MEGA40-NEWCOF



NUOVA SIMONELLI 16300121

3319934 ORANGE BIPOLAR SWITCH 16A 250V
with indicator lamp
0-1 silk-screen printing
max temperature 120°C
mounting hole 22x30 mm



NUOVA SIMONELLI 15010045

3319019 RED BIPOLAR SWITCH 16A 250V
with indicator lamp
max temperature 120°C
mounting hole 22x30 mm

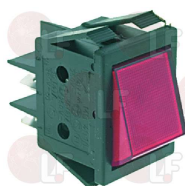

NUOVA SIMONELLI 04200011

1319160 THREE-POLE LEVER SWITCH 10A 400V
for Grinder-dispenser (BRASILIA) R80
for Grinder-dispenser (CASADIO) GC98 - G84
MOKABIX
for Grinder-dispenser (ROSSI) R80



NUOVA SIMONELLI

Tampers for coffee

1385053 ANODISED ALUMINUM TAMPER ø 58 mm
flat pressing area



NUOVA SIMONELLI

1385005 BALL ALUMINUM TAMPER ø 57 mm



NUOVA SIMONELLI

Suitable for:

1385012 COFFEE TAMPER ø 56 mm



NUOVA SIMONELLI 15000067

Suitable for:

1241911 COFFEE TAMPER HANDLE



NUOVA SIMONELLI

1385002 NYLON COFFEE TAMPER ø 50/57 mm



NUOVA SIMONELLI 05080035

1324932 PIN FOR MANUAL COFFEE TAMPER



NUOVA SIMONELLI

Terminal blocks

3247016 3-POLE TERMINAL BLOCK FV273 40A 450V

for cable max 6 mm²
operating temperature 150°C
nominal voltage 450 V



NUOVA SIMONELLI 04000310

Trays

1252385 COFFEE COLLECTING TRAY ø 170 mm

for Grinder-dispenser (EUREKA) LUSO MDLC
LUSO MDLCA/C - LUSO MDLCA65 - LUSO MDML
MONDIAL MDMC - MONDIAL MDME
for Grinder-dispenser (NUOVA SIMONELLI) MDL
MDLCA - MDLCA/C - MDX - MDXA



NUOVA SIMONELLI 15080038

The data herewith contained may change without notice and LF SpA cannot be held responsible for possible errors stated or resulting by the use of this document. All rights reserved. No part of this publication may be reproduced without written permission by LF SpA.



LF SpA
via Voltri, 80 - 47522 Cesena (FC) ITALIA
Tel. +39 0547 34 11 11 - Fax +39 0547 34 11 10
www.lfricambi724.it - www.lfricambi724.mobi
info@lfricambi.it
Export Dept.: Tel. +39 0547 34 11 50 - Fax: +39 0547 34 11 55
www.lfspareparts724.com - www.lfspareparts724.mobi
export@lfspaceparts.com

FRANCE



EPGC Sas
13, Rue des Forts - 59960 Neuville en Ferrain
Tél. +33 (0)3 20 25 06 21
Fax +33 (0)3 20 25 34 12
www.epgc.com
www.epgc724.mobi
epgc@epgc.com

DEUTSCHLAND



LF GmbH
Junkersstrasse, 1 - D-82178 Puchheim - München
Tel. +49 89 89 45 78 66
Fax +49 89 89 45 78 88
www.lfersatzteile724.de
www.lfersatzteile724.mobi
info@lfersatzteile.de

SCHWEIZ



LF GmbH Verkaufsbüro
Sennweidstrasse, 45 - CH-6312 Steinhausen
Tel. +41 (0)41 760 15 80-1
Fax +41 (0)41 760 15 85
www.lfersatzteile724.ch
www.lfersatzteile724.mobi
info@lfersatzteile.ch

ESPAÑA



LF Repuestos Horeca S.L.U.
Calle Ciudad Real, 10 - 45517 Escalonilla - Toledo
Tif. +34 91 477 91 00
Fax +34 91 477 90 81
www.lfrepuestos724.es
www.lfrepuestos724.mobi
info@lfrepuestos.es

UNITED KINGDOM



LF Spare Parts Ltd.
A10a Lakeside Business Park, Broadway Lane
South Cerney, Gloucestershire GL7 5XL
Tel. +44 (0)1285 86 16 25
Fax +44 (0)1285 86 39 49
www.lfspareparts724.co.uk
www.lfspareparts724.mobi
info@lfspaceparts.co.uk

RUSSIA



OOO LF
ul, Anatoliya Zhivova, 8 - office 1 - 123100 Moscow
Tel. +7 499 259 85 75
Fax +7 495 725 26 53
www.lfspareparts724.ru
www.lfspareparts724.mobi
info@lfspaceparts.ru

CHINA



LF China
Room 102, House 8, Lane 725, Mao Tai Rd.
Changning Dist. - 200336 Shanghai
Tel. +86 (0)21 33 53 66 31
Fax +86 (0)21 33 53 66 32
www.lfspareparts724.com
www.lfspareparts724.mobi
china@lfspaceparts.com