

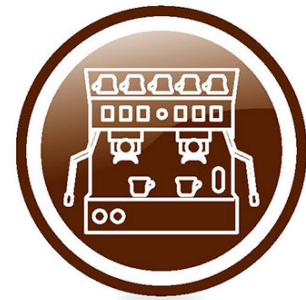

Spare parts for:

## Espresso coffee machines



Suitable for:

# ROYAL



This catalogue is automatically generated.  
Therefore, the sequence of the items might  
not be always shown at best.

Updates will be issued in case of additions  
and/or amendments.

*Suitable universal spare parts may not be included*





GROUP

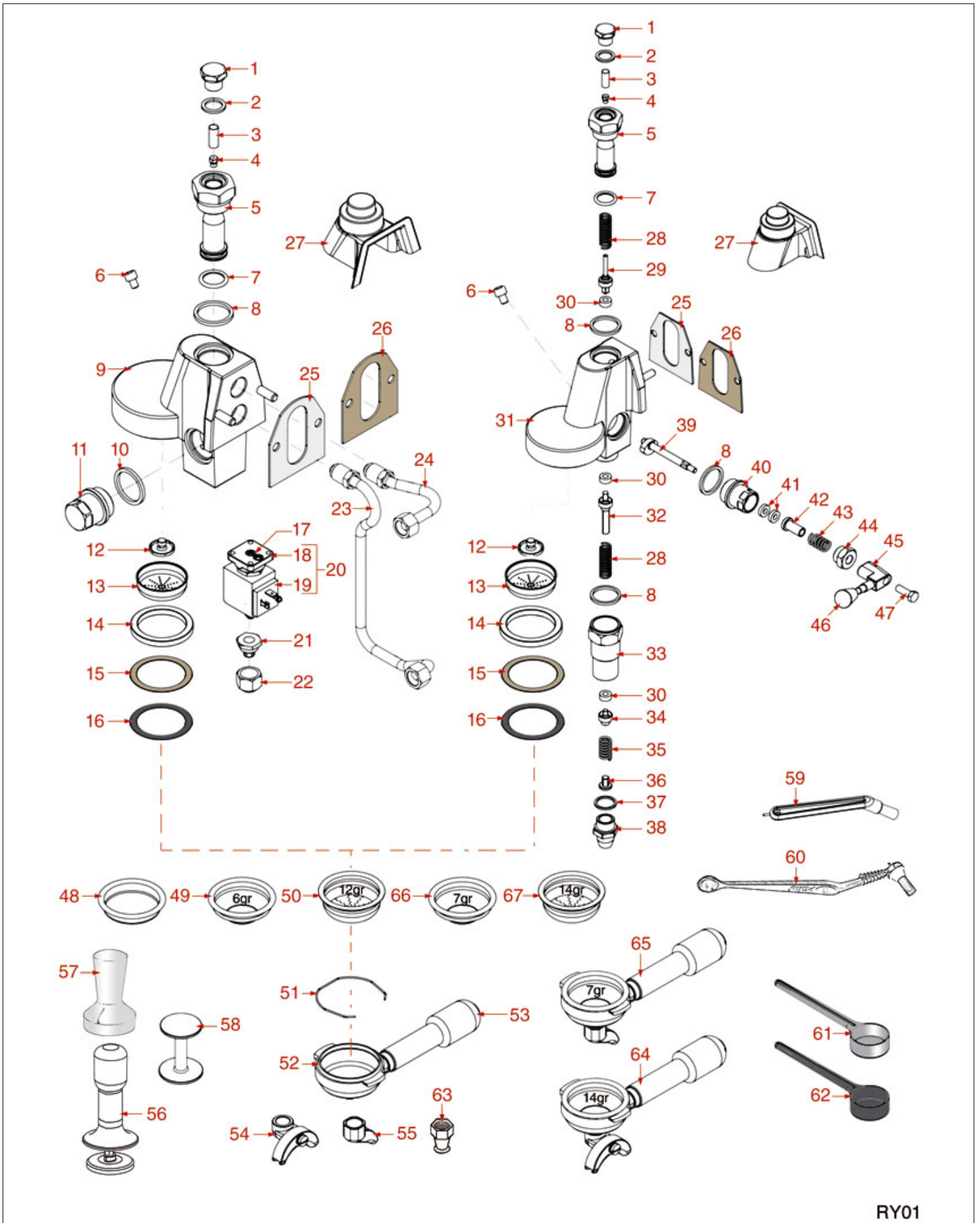

RY01

Positions without LF code no.: upon request



# ROYAL



Position	LF code no.	Description
1	1439001	CAP ø 16 mm FOR BREW GROUP
2	1186326	PTFE FLAT GASKET ø 22x16x2 mm
3	1160517	WATER FILTER ø 8.5x22 mm
4	1501541	NOZZLE M6x1 HOLE ø 0,8 mm
5	1027016	UPPER CHROMIUM-PLATED SLEEVE
7	1186472	O-RING 04075 EPDM
8	1186307	PTFE FLAT GASKET ø 36x30x2 mm
10	1186307	PTFE FLAT GASKET ø 36x30x2 mm
12	1501561	GROUP SPRAY NOZZLE ø 30 mm M10x1
13	1081016	SHOWER SCREEN ø 60 mm
13	1081116	SHOWER SCREEN ø 60 mm
13	1081216	SHOWER SCREEN ø 60 mm
13	1081516	SHOWER ø 60 mm
14	1186891	FILTER HOLDER GASKET ø 73x57x8 mm
15	1190001	PAPER SHIM ø 73x59x0.8 mm
16	1190002	RUBBER SHIM ø 73x59x1 mm EPDM
17	1186611	O-RING 02025 RED SILICONE
17	1186612	O-RING 02025 VITON
18	1120334	3-WAY MECHANICAL COMPONENT LUCIFER
18	1120339	3-WAY MECHANICAL COMPONENT PARKER
19	1120332	COIL LUCIFER/PARKER 220/240V 9W 50Hz
19	1120820	COIL ODE BDA08223DS 220/230V 50Hz 8W
19	3120032	COIL PARKER ZB09 9W 220/240V 50/60Hz
20	1120330	3-WAY SOLENOID VALVE LUCIFER 240V 50Hz
20	1120335	3-WAY SOLENOID VALVE PARKER 230V 50/60Hz
20	1120805	SOLENOID VALVE ODE 3 WAYS 230V 8W
25	1186508	COFFEE GROUP GASKET 77x73x2 mm
26	1186384	COFFEE GROUP GASKET 80x70x2 mm
28	1250537	SPRING ø 14x45 mm
29	1523451	COMPLETE SPOUT VALVE
30	1186311	NBR FLAT GASKET ø 13x4x4 mm
32	1523452	COMPLETE DRAIN VALVE
33	1027002	OUTLET CHROMIUM-PLATED SLEEVE
35	1250515	SPRING ø 14x33 mm
37	1186314	PTFE FLAT GASKET ø 22x17x2 mm
38	1439006	DRAIN CHROMIUM-PLATED FITTING
39	1324048	CAM ROD FOR COFFEE GROUP
41	1186312	EPDM FLAT GASKET ø 15.5x7.5x4 mm
42	1186313	CAM GUIDE BUSHING
43	1250516	SPRING ø 15x28 mm
46	1241401	KNOB M8x1
48	1160339	BLIND FILTER
49	1160251	1 CUP FILTER 6 g
50	1160252	2-CUP FILTER 12 GRAMS
51	1250002	S/STEEL FILTER LOCKING SPRING ø 1.20 mm
52	1165064	FILTER HOLDER BFC/ROYAL/RK
53	1241501	FILTER HOLDER HANDLE M12
54	1022506	DOUBLE SPOUT ø 3/8"
55	1022501	SINGLE SPOUT ø 3/8"
56	1385600	DYNAMOMETRIC MANUAL COFFEE TAMPER ø 57mm
56	1385602	MANUAL DYNAMOMETRICAL TAMPER ø 57 mm
57	1385053	ANODISED ALUMINUM TAMPER ø 58 mm
58	1385002	NYLON COFFEE TAMPER ø 50/57 mm
59	1384001	BRUSH FOR COFFEE SHOWER
60	1384003	BLACK SHOWER CLEANING BRUSH
61	1069002	STAINLESS STEEL MEASURING SPOON 20 ml
62	1069001	PLASTIC MEASURING SPOON 20 ml
63	1022503	STRAIGHT SINGLE SPOUT ø 3/8"
64	1165301	2 CUPS FILTER HOLDER ASSEMBLY BFC/ROYAL
65	1165300	1 CUP FILTER HOLDER ASSEMBLY BFC/ROYAL
66	1160335	1 CUP FILTER 7 g
67	1160337	2-CUP FILTER 14 GRAMS



## WATER/STEAM INLET TAP

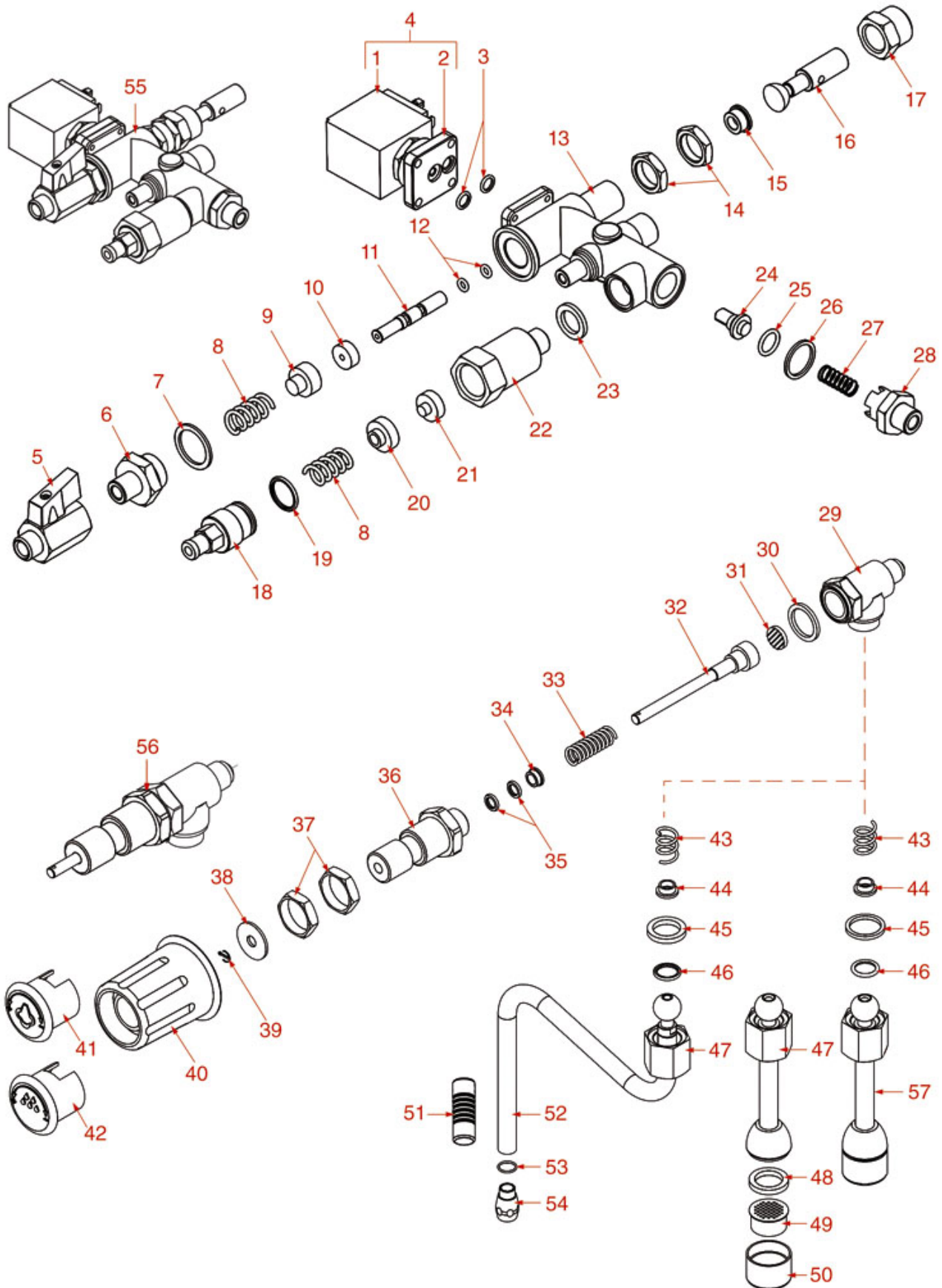



# ROYAL



Position	LF code no.	Description
1	1120332	COIL LUCIFER/PARKER 220/240V 9W 50Hz
1	3120032	COIL PARKER ZB09 9W 220/240V 50/60Hz
2	1120334	3-WAY MECHANICAL COMPONENT LUCIFER
2	1120339	3-WAY MECHANICAL COMPONENT PARKER
3	1186611	O-RING 02025 RED SILICONE
3	1186612	O-RING 02025 VITON
4	1120330	3-WAY SOLENOID VALVE LUCIFER 240V 50Hz
4	1120335	3-WAY SOLENOID VALVE PARKER 230V 50/60Hz
5	3526699	BALL VALVE $\varnothing$ 1/4" MF
7	1186620	COPPER FLAT GASKET $\varnothing$ 22x17x1.5 mm
12	1186900	O-RING 02015 VITON
14	1348036	NUT $\varnothing$ 3/8" WRENCH 21x6mm
17	1348344	CHROMIUM-PLATED NUT 3/8
23	1186404	PTFE FLAT GASKET $\varnothing$ 18x13x2 mm
24	1523401	SQUARE NON-RETURN VALVE
28	1349112	FITTING $\varnothing$ 1/4"M-3/8"M
30	1186171	ROUND COPPER GASKET $\varnothing$ 22x16.5x2.2 mm
32	1324066	WATER/STEAM TAP PIN
33	1250415	TAP SPRING $\varnothing$ 10x32 mm
34	1186244	SPRING BUSHING
35	1186612	O-RING 02025 VITON
36	1349471	TAP PIN
37	1349504	NUT $\varnothing$ 1/2" KEY 25x6 mm
38	1528059	WASHER FLAT LARGE M6
39	3389013	STAINLESS STEEL PIN $\varnothing$ 2x12 mm
40	1241321	WATER/STEAM TAP HANDLE
41	1241322	STEAM CAP FOR KNOB
42	1241045	WATER CAP FOR KNOB
45	1186372	CONICAL PTFE SEAL $\varnothing$ 14.5x10.5x4.5 mm
46	3060608	O-RING O3050 EPDM
47	1349064	NUT $\varnothing$ 3/8"F FOR WATER STEAM PIPE
56	1348056	WATER/STEAM TAP
57	1449167	COMPLETE WATER PIPE



LEVEL AND ROTARY VANE PUMP

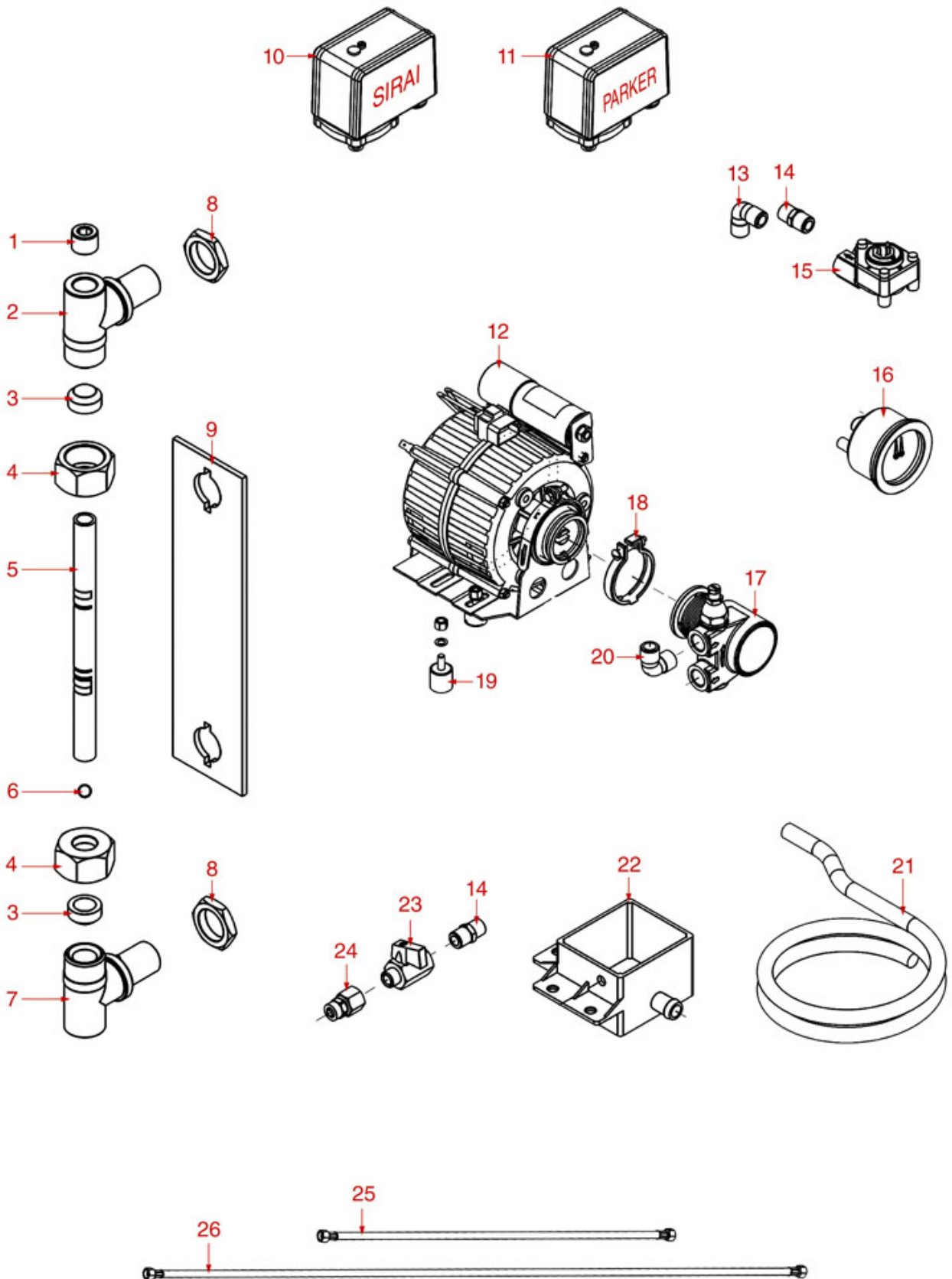



# ROYAL



Position	LF code no.	Description
3	1186206	EPDM FLAT GASKET $\varnothing$ 16x10x8 mm
5	1520546	LEVEL GLASS $\varnothing$ 11x140 mm
6	1323006	BLACK LEVEL BALL $\varnothing$ 7 mm
10	1320531	PRESSURE SWITCH P302/6 3-POLES 30A
11	1320541	PRESSURE SWITCH PARKER
13	1349102	FITTING $\varnothing$ 1/4"M-1/4"M
15	1455067	VOLUMETRIC FLOWMETER GICAR
16	1245043	BOILER-PUMP PRESSURE GAUGE $\varnothing$ 63 mm
16	1245050	BOILER-PUMP PRESSURE GAUGE $\varnothing$ 63 mm
17	1330002	ROTARY VANE PUMP ROTOFLOW $\varnothing$ 3/8" NPT
18	1168011	STAINLESS STEEL CLAMP FOR FLANGE PUMP
20	1349706	L-FITTING $\varnothing$ 3/8"M-3/8"M NICKEL-PLATED
22	1527511	DRAIN TUB
23	3526699	BALL VALVE $\varnothing$ 1/4" MF
25	1449712	FLEX HOSE $\varnothing$ 3/8" Fp x Fc 800 mm
26	1449713	FLEX HOSE $\varnothing$ 3/8" Fp x Fc 1000 mm



BOILER

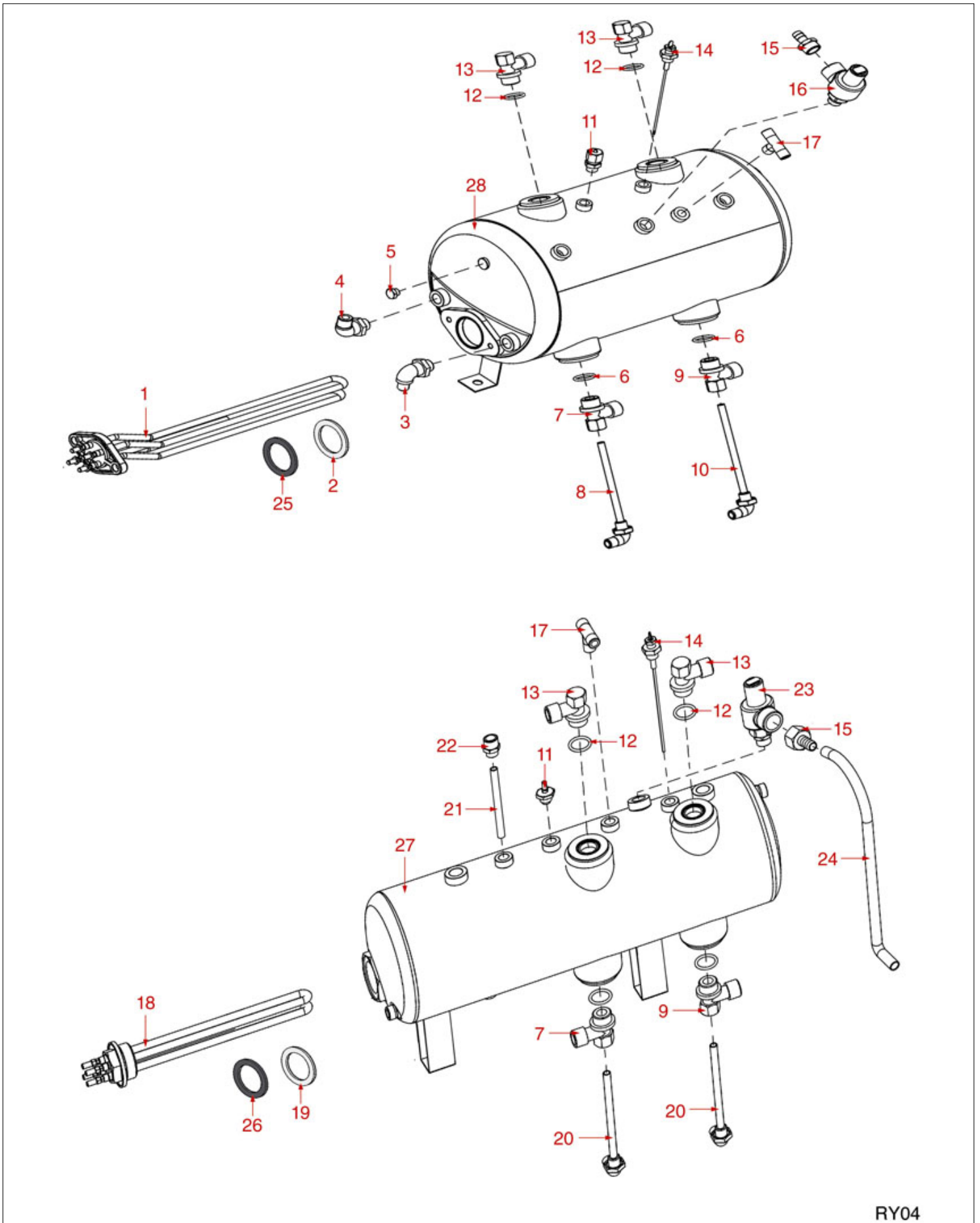

RY04

Positions without LF code no.: upon request





# ROYAL



Position	LF code no.	Description
1	1755210	HEATING ELEMENT 3500W 230V
1	1755211	HEATING ELEMENT 5200W 230V
2	1186179	PTFE FLAT GASKET $\varnothing$ 57x43x3 mm
6	1186445	ROUND COPPER GASKET $\varnothing$ 26x21.4x2 mm
11	1523534	BOILER VALVE $\varnothing$ 1/4"M
11	1523537	BOILER VALVE $\varnothing$ 1/4"M
11	1523538	BOILER VALVE $\varnothing$ 1/4"M
12	1186445	ROUND COPPER GASKET $\varnothing$ 26x21.4x2 mm
15	3349348	NICHEL-PL.HOSE-END FITTING $\varnothing$ 1/2"M $\varnothing$ 12
16	1515006	BOILER TAP $\varnothing$ 3/8"M - 1.8 bar CE/PED
17	3349340	NICHEL-PL.T-FITTING $\varnothing$ 1/4"M-1/4"M-1/4"M
18	1755208	HEATING ELEMENT 3300W 230V
18	1755209	HEATING ELEMENT 4000W 230V
19	1186623	PTFE FLAT GASKET $\varnothing$ 53x43x3 mm
25	1186606	FLAT CARBO GASKET $\varnothing$ 57x43x3 mm
26	1186633	FLAT CARBO GASKET $\varnothing$ 53x42x3 mm



ELECTRICAL PARTS

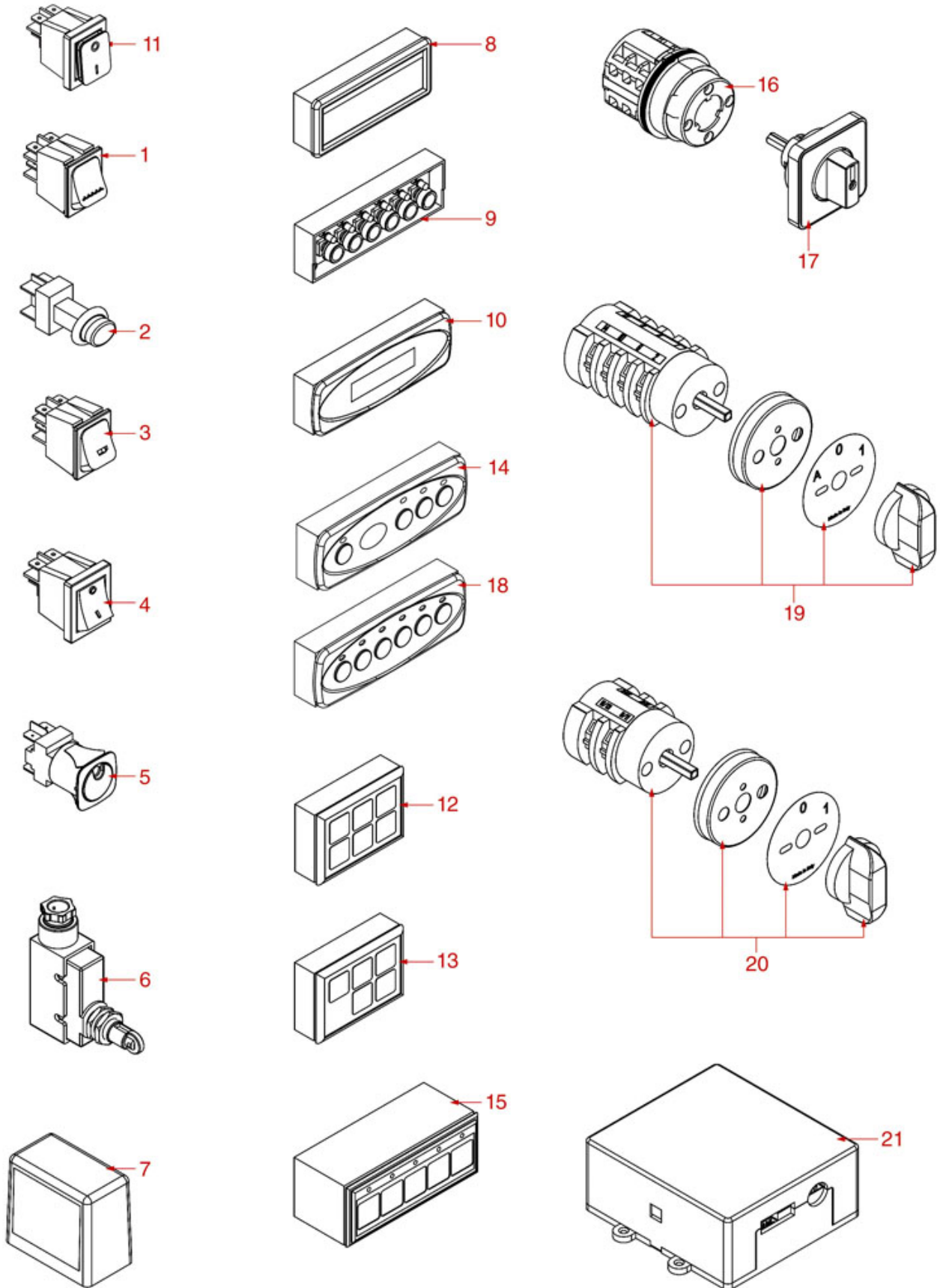



# ROYAL



Position	LF code no.	Description
1	1319033	WHITE BIPOLAR PUSH-BUTTON 16A 250V
3	1319035	WHITE BIPOLAR SWITCH 16A 250V
4	3319933	SWITCH 2-POLE RED 16A 250V
5	1319561	BLACK BIPOLAR SWITCH 16A 250V
6	1240841	MICROSWITCH 15A 250V
13	5057512	PUSH-BUTTON PANEL 5 BUTTONS



**ROYAL**



## UNIVERSAL SPOUTS



Photo	LF Code	Connection ( $\varnothing$ )
1	1022501	3/8
2	1022504	3/8
3	1022503	3/8
4	5031337	3/8

## UNIVERSAL SPOUTS



Photo	LF Code	Connection ( $\varnothing$ )
1	1022502	3/8
2	1022521	3/8
3	1022523	3/8
4	1022522	3/8
5	1022551	3/8

## "PRECISION" SHOWER SCREENS ROYAL



Photo	LF Code	Dimensions	Membrane	Suitable for	For machine model
1	1460200	$\varnothing$ 51.5 mm	200 $\mu$ M	ROYAL	SYNCHRO
2	1460205	$\varnothing$ 51.5 mm	35 $\mu$ M	ROYAL	SYNCHRO
3	1081400	$\varnothing$ 51.5 mm	200 $\mu$ M PTFE	ROYAL	SYNCHRO
4	1460201	$\varnothing$ 60.0 mm	200 $\mu$ M	ROYAL	DIADEMA
5	1460206	$\varnothing$ 60.0 mm	35 $\mu$ M	ROYAL	DIADEMA
6	1081401	$\varnothing$ 60.0 mm	200 $\mu$ M PTFE	ROYAL	DIADEMA

Docce progettate per ottenere la perfetta estrazione del caffè , acciaio Aisi 316 , certificate alimentare



ASBESTOS FREE FLAT GASKETS



LF Code	Dimensions	Notes
1186042	∅ 9x5x1 mm	---
3186341	∅ 9x6x1 mm	---
3786349	∅ 14x9x2 mm	---
1186041	∅ 14.5x10x2 mm	---
1186148	∅ 15x7x2 mm	---
3186172	∅ 15x9x2 mm	---
1186112	∅ 15x10x1 mm	---
1186437	∅ 16x12x2 mm	---
1186039	∅ 17x13x2 mm	---
1186784	∅ 17.5x13x2 mm	---
3786543	∅ 18x12x1 mm	---
3786562	∅ 18x12x2 mm	---
3786350	∅ 18x12x2 mm	---
3186237	∅ 19x11x2 mm	---
1186394	∅ 22x17x2 mm	---
1186149	∅ 22x18x2 mm	---
1186368	∅ 23.5x20x1 mm	---
3786351	∅ 24x16x2 mm	---
3186575	∅ 25x12x2 mm	---
1186340	∅ 26x20x2 mm	---
1186183	∅ 29x16.5x2 mm	---
1186136	∅ 29x22x2 mm	---
3186138	∅ 30x21x2 mm	---
1186124	∅ 30x24x2 mm	---
3186005	∅ 32x26x3 mm	---
1186141	∅ 34x26.5x2 mm	---
1186757	∅ 36x30x2 mm	---
3186009	∅ 45x33x2 mm	---
1186125	∅ 50x38x4 mm	---
1186156	∅ 50x40x2 mm	FOR HEATING ELEMENTS BOOSTED - PER RESISTENZE BOOSTED
1786227	∅ 54x40x1.5 mm	---
3186010	∅ 54x42x2 mm	FOR HEATING ELEMENTS ∅ 1"1/4 - PER RESISTENZE ∅ 1"1/4
3786374	∅ 57x45x1.5 mm	---
3186242	∅ 61x46x2 mm	---
1186636	∅ 62x51x2 mm	FOR HEATING ELEMENTS - PER RESISTENZE
3186012	∅ 80x60x2 mm	---
3786471	∅ 90x77x2 mm	---

## BALL VALVES



Photo	LF Code	Connections	Suitable for	For machine model
1	3526706	∅ 1/8"FF	UNIVERSAL	---
1	3526698	∅ 1/4"FF	BEZZERA 7451501	BZ35 - BZ40 - B2000 - B2013 - B3000 - B4000 - B6000
1	3526698	∅ 1/4"FF	SPAZIALE 08103	S5 COMPACT - S8 COMPACT - S9 COMPACT
1	3526702	∅ 3/8"FF	UNIVERSAL	---
1	3526703	∅ 1/2"FF	UNIVERSAL	---
1	3526707	∅ 3/4"FF	UNIVERSAL	---
2	3526697	∅ 1/8"MF	SAN MARCO 202241	NEW 105 - 100 - 105 - 85 - 95
2	3526699	∅ 1/4"MF	MANY BRANDS - MOLTI MARCHI	SEVERAL APPLICATIONS - MOLTE APPLICAZIONI
2	3526244	∅ 1/4"M-1/8"F	SAN MARCO 202244	95 - 105
2	3526704	∅ 3/8"MF	MARZOCCO L164	FB70 - FB80 - GB5 - GS3 - LINEA - MISTRAL
2	3526704	∅ 3/8"MF	NUOVA SIMONELLI 09000016	APPPIA - AURELIA - PREMIER
2	3526704	∅ 3/8"MF	VICTORIA ARDUINO 09000016	ADONIS - ATHENA - ATHENA LEVA
2	3526705	∅ 1/2"MF	UNIVERSAL	---
3	1525002	∅ 1/4"M-1/4"F	ASTORIA/CMA 20227003	PLUS4YOU
3	1525002	∅ 1/4"M-1/4"F	WEGA WY20227003	CONCEPT

## BLIND GASKETS ROYAL



1

Photo	LF Code	Dimensions	Material	Suitable for
1	1186442	∅ 12x5.8 mm	SILICON	ROYAL 0540085

## BOILER SAFETY VALVES



1

2

Photo	LF Code	Technical notes	Suitable for
1	1515100	∅ 3/8"M 1.8 bar CE-PED	ALL BRANDS - TUTTE LE MARCHE
1	1515120	∅ 3/8"M 1.9 bar CE-PED	ALL BRANDS - TUTTE LE MARCHE
2	1515110	∅ 1/2"M 1.8 bar CE-PED	ALL BRANDS - TUTTE LE MARCHE
2	1523022	∅ 1/2"M 1.5 bar CE-PED	SPAZIALE



**BOILER SAFETY VALVES**



Photo	LF Code	Technical notes	Suitable for
1	1523543	∅ M18x1.5 1.8 bar	SAN MARCO OLD - VERSIONI VECCHIE
1	1523545	∅ M19x1.5 1.8 bar	GAGGIA OLD - VERSIONI VECCHIE
1	1523544	∅ M22x1.5 1.8 bar	PAVONI OLD - VERSIONI VECCHIE
2	1515003	∅ 1/4" M 2.1 bar	NUOVA SIMONELLI - VICTORIA ARDUINO
3	1523121	∅ 3/8" M 1.5 bar CE-PED	ELEKTRA
3	1523029	∅ 3/8" M 1.6 bar CE-PED	EXPOBAR - PROMAC - RANCILIO
3	1523059	∅ 3/8" M 1.8 bar CE-PED	ALL BRANDS - TUTTE LE MARCHE
3	1515025	∅ 3/8" M 1.9 bar CE-PED	CARIMALI - RANCILIO
3	1515007	∅ 3/8" M 2.0 bar CE-PED	CIMBALI - FAEMA
4	1523574	∅ 3/8" M 1.1 bar CE-PED	---
4	1523003	∅ 3/8" M 1.6 bar CE-PED	BRASILIA - FIAMMA - SAB ITALIA
4	1523572	∅ 3/8" M 1.8 bar CE-PED	ALL BRANDS - TUTTE LE MARCHE
5	1523571	∅ 1/4" M 1.8 bar CE-PED	---
5	1515004	∅ 1/4" M 2.0 bar CE-PED	CASADIO - CIMBALI - FAEMA
5	1515005	∅ 3/8" M 1.8 bar CE-PED	SANREMO
6	1515006	∅ 3/8" M-3/8" M 1.8 bar CE-PED	BFC - ROYAL
6	1515017	∅ 3/8" M-3/4" M 1.8 bar CE-PED	GAGGIA

**BOTTOMLESS FILTER HOLDERS**



LF Code	Suitable for	Wings	Adapter filter for pods	Notes
1165034	Astoria / CMA	6.0 mm	No	---
1165117	Astoria / CMA	6.5 mm	No	Plus 4 you / Concept
1165181	Bezzera	5.8 mm	Yes	---
1165035	Brasilia	5.5 mm	Yes	---
1165038	Carimali	6.0 mm	No	---
1165182	Cimbali	5.5 mm	Yes	---
1165039	Conti	8.0 mm	No	---
1165119	Dalla Corte	9.0 mm	No	---
1165192	Expobar	6.2 mm	Yes	---
1165183	Faema	7.2 mm	Yes	---
1165195	Fiorenzato cs	6.4 mm	Yes	---
1165184	Futurmat	7.2 mm	No	---
1165185	Gaggia	6.6 mm	Yes	---
1165194	Grimac	7.0 mm	Yes	---
1165186	Marzocco	6.5 mm	Yes	---
1165086	Marzocco	6.8 mm	Yes	---
1165118	Nuova Simonelli	7.0 mm	No	Slanted body / Corpo inclinato





LF Code	Suitable for	Wings	Adapter filter for pods	Notes
5030988	Pavoni	5.6 mm	Yes	---
1165187	Rancilio	6.2 mm	Yes	---
1165185	Saeco	6.6 mm	No	---
1165191	San Marco	7.0 mm	Yes	---
1165193	Sanremo	6.4 mm	Yes	---
5050620	Spaziale	6.0 mm	Yes	---
1165188	Vibiemme	6.2 mm	Yes	---
1165189	Wega	6.4 mm	Yes	---

## BRASS WASHERS



LF Code	Dimensions	Suitable for	Notes
1186446	∅ 28x17x2 mm	ASTORIA/CMA 25651	SEVERAL APPLICATIONS - MOLTE APPLICAZIONI
1186035	---	ASTORIA/CMA 25652	FOR LEVEL - PER LIVELLO
1528095	∅ 15.4x9x1 mm	ASTORIA/CMA 25653	FOR INLET TAPS - PER RUBINETTI CARICO
1186376	∅ 12x8x1 mm	ASTORIA/CMA 25655	FOR STEAM/WATER TAPS - PER RUBINETTI VAPORE/ACQUA
1186298	∅ 13x6x0.5 mm	CIMBALI	FOR BREW GROUPS - PER GRUPPI EROGAZIONE
1186380	---	ELEKTRA 01380035	FOR LEVEL - PER LIVELLO
1186319	∅ 13.9x8.3x1 mm	FAEMA 4051050569	FOR STEAM/WATER TAPS - PER RUBINETTI VAPORE/ACQUA
1186330	∅ 6.8x3.2x0.5 mm	FAEMA 4051136002	FOR BREW GROUPS - PER GRUPPI EROGAZIONE
1528130	∅ 26x16.5x1 mm	FAEMA 4051052071	FOR STEAM/WATER TAPS - PER RUBINETTI VAPORE/ACQUA
1186330	∅ 6.8x3.2x0.5 mm	FUTURMAT 04527503	FOR BREW GROUPS - PER GRUPPI EROGAZIONE
1186306	∅ 10x5x1 mm	FUTURMAT 04715801	FOR BREW GROUPS - PER GRUPPI EROGAZIONE
1186283	∅ 14.5x7x2 mm	FUTURMAT 08165508	FOR STEAM/WATER TAPS - PER RUBINETTI VAPORE/ACQUA
1528029	∅ 12x7x1 mm	GAGGIA S313001	G105 - G106
1528025	∅ 17x12x1 mm	GAGGIA S313003	G105 - G106
1186685	---	GRIMAC 1300900066-GR296	FOR LEVEL - PER LIVELLO
1186732	∅ 15x8.4x1 mm	GRIMAC GR354	FOR STEAM/WATER TAPS - PER RUBINETTI VAPORE/ACQUA
1186681	---	GRIMAC GR738	FOR STEAM/WATER TAPS - PER RUBINETTI VAPORE/ACQUA
1528018	∅ 14x6.5x0.5 mm	MARZOCCO I.4.001	FOR STEAM/WATER TAPS - PER RUBINETTI VAPORE/ACQUA
1528130	∅ 26x16.5x1 mm	MARZOCCO L165/2	FOR BREW GROUPS - PER GRUPPI EROGAZIONE
1186035	---	MCE 25652	FOR LEVEL - PER LIVELLO
1186035	---	ORCHESTRALE D25652	FOR LEVEL - PER LIVELLO
1528029	∅ 12x7x1 mm	PAVONI 313001	EUROPICCOLA - PROFESSIONAL - ROMANTICA - STRADIVARI
1528025	∅ 17x12x1 mm	PAVONI 313003	EUROPICCOLA - PROFESSIONAL - ROMANTICA - STRADIVARI
1528028	∅ 14.5x9.5x1.5 mm	PAVONI 313004	EUROPICCOLA - PROFESSIONAL - STRADIVARI
1186330	∅ 6.8x3.2x0.5 mm	PAVONI 401050	FOR BREW GROUPS - PER GRUPPI EROGAZIONE
1186814	---	RANCILIO 23123003	FOR STEAM/WATER TAPS - PER RUBINETTI VAPORE/ACQUA
1186807	∅ 18x13x0.5 mm	RANCILIO 23131005	FOR LEVEL - PER LIVELLO
1528017	∅ 17x9x1 mm	RANCILIO 32239002	FOR STEAM/WATER TAPS - PER RUBINETTI VAPORE/ACQUA
1186992	∅ 15x7x0.8 mm	SAN MARCO 205081	FOR BREW GROUPS - PER GRUPPI EROGAZIONE
1186462	∅ 12x8x2 mm	SAN MARCO 205305	FOR INLET TAPS - PER RUBINETTI CARICO
1528018	∅ 14x6.5x0.5 mm	SCALA C-0270	FOR STEAM/WATER TAPS - PER RUBINETTI VAPORE/ACQUA
1186732	∅ 15x8.4x1 mm	VIBIEMME RACCROGU	FOR STEAM/WATER TAPS - PER RUBINETTI VAPORE/ACQUA
1186330	∅ 6.8x3.2x0.5 mm	VIBIEMME RACCROPOGU	FOR STEAM/WATER TAPS - PER RUBINETTI VAPORE/ACQUA
1186306	∅ 10x5x1 mm	WEGA W10526	FOR INLET TAPS - PER RUBINETTI CARICO
1186446	∅ 28x17x2 mm	WEGA WY25651	SEVERAL APPLICATIONS - MOLTE APPLICAZIONI
1186035	---	WEGA WY25652	FOR LEVEL - PER LIVELLO
1528095	∅ 15.4x9x1 mm	WEGA WY25653	FOR INLET TAPS - PER RUBINETTI CARICO
1186376	∅ 12x8x1 mm	WEGA WY25655	FOR STEAM/WATER TAPS - PER RUBINETTI VAPORE/ACQUA
1186330	∅ 6.8x3.2x0.5 mm	WEGA WY27421011	FOR BREW GROUPS - PER GRUPPI EROGAZIONE



# ROYAL



## CAPPUCCINATORE MINI



Photo	LF Code	Suitable for
1	1079001	BRASILIA - GRIMAC - SAECO
2	1079008	GRIMAC - PAVONI - RDL - SAECO - SPINEL
3	1079018	BFC - BRASILIA - GRIMAC - SAECO
4	5500786	BRASILIA - GRIMAC - SAECO
5	1079015	GRIMAC - PAVONI - RDL - SAECO - SPINEL

## CAPPUCCINATORE STANDARD



Photo	LF Code	Suitable for
1	1079022	ASTORIA/CMA - CARIMALI - NUOVA SIMONELLI - WEGA
2	1079002	BRASILIA - BRUGNETTI - CARIMALI - NUOVA SIMONELLI
3	1079006	UNIVERSAL

## CAPS ROYAL



Photo	LF Code	Dimensions	Notes	Suitable for	For machine model
1	1439001	∅ 16 mm	FOR BREW GROUPS - PER GRUPPI EROGAZIONE	ROYAL 0520000	DIADEMA - SYNCHRO
2	3349622	∅ 1/8" M	FOR BOILERS - PER CALDAIE	ROYAL 3530022	SYNCHRO



## CARBO FLAT GASKETS



LF Code	Dimensions	Suitable for	Notes
1186517	ø 31x21x3 mm	---	---
1186547	ø 32x24x1.5 mm	NUOVA SIMONELLI	FOR BREW GROUPS - PER GRUPPI EROGAZIONE
1186627	ø 41x33x3 mm	---	FOR HEATING ELEMENTS ø 1" - PER RESISTENZE ø 1"
1786215	ø 50x40x2 mm	ASTORIA/CMA	FOR HEATING ELEMENTS BOOSTED - PER RESISTENZE BOOSTED
1186633	ø 53x42x3 mm	---	FOR HEATING ELEMENTS ø 1"1/4 - PER RESISTENZE ø 1"1/4
1186942	ø 55x42x2 mm	ELEKTRA	FOR HEATING ELEMENTS - PER RESISTENZE
1186637	ø 56x47x3 mm	SAN MARCO	FOR HEATING ELEMENTS - PER RESISTENZE
1186606	ø 57x43x3 mm	---	FOR HEATING ELEMENTS MOD FAEMA - PER RESISTENZE MOD FAEMA
1186607	ø 57.8x50x3 mm	CIMBALI	FOR HEATING ELEMENTS - PER RESISTENZE
3186011	ø 63x48x2 mm	RANCILIO	FOR HEATING ELEMENTS - PER RESISTENZE
1186638	ø 67x55x3 mm	NUOVA SIMONELLI	FOR HEATING ELEMENTS - PER RESISTENZE
1186548	ø 73x61.5x1.5 mm	NUOVA SIMONELLI	FOR BREW GROUPS - PER GRUPPI EROGAZIONE
1186320	ø 87x81x0.5 mm	MARZOCCO	FOR BREW GROUPS - PER GRUPPI EROGAZIONE

## COFFEE FILTERS ROYAL



Photo	LF Code	Model	Suitable for	Notes
1	1160251	1 CUP - 6 gr	ROYAL	---
1	1160335	1 CUP - 7 gr	ROYAL 4630051	---
2	1160252	2 CUPS - 12 gr	ROYAL	---
2	1160337	2 CUPS - 14 gr	ROYAL 4630052	---
1	1160281	1 CUP - 7 gr	ROYAL	AISI 430 ECONOMIC
2	1160282	2 CUPS - 14 gr	ROYAL	AISI 430 ECONOMIC
3	1160339	BLIND - CIECO	ROYAL 4630100	---



**COFFEE GROUPS AND SPARE PARTS ROYAL**



Photo	LF Code	Suitable for	For machine model
1	1027002	ROYAL 0530040	DIADEMA - SYNCHRO
2	1027016	ROYAL 0520030	DIADEMA - SYNCHRO
3	1349022	ROYAL 0530090	DIADEMA - SYNCHRO
4	1439006	ROYAL 0530060	DIADEMA - SYNCHRO

**COFFEE GROUPS AND SPARE PARTS ROYAL**



Photo	LF Code	Suitable for	For machine model
1	1186313	ROYAL	DIADEMA - SYNCHRO
2	1523451	ROYAL 0530001	DIADEMA - SYNCHRO
3	1523452	ROYAL 0530020	DIADEMA - SYNCHRO

**COFFEE GROUPS SPRINKLERS**



Photo	LF Code	Dimensions	Hole	Suitable for	For machine model
1	1501565	ø 21 mm M5x1	---	FAEMA 4161133848	COMPACT - DUE - ELITE - ENOVA - EXPRESS - E61
1	1501565	ø 21 mm M5x1	---	FUTURMAT 02476109	---
2	1510004	ø 21 mm M5x1	---	CASADIO 457342000	DIECIA - DIECIS
2	1510004	ø 21 mm M5x1	---	CIMBALI 457-342-000	M27 2008
2	1510004	ø 21 mm M5x1	---	FAEMA 457342000	DUESMART - EMBLEMA - ENOVA - E61 - SMARTRETTY
3	1501560	ø 21 mm M6x1	---	VIBIEMME RACCSPGRKO	EVOLUTION - KOMETA - LOLLO - MINIMAX - SILVER
4	1501007	ø 30 mm M10x1	M5	MCE 27105000	START
4	1501007	ø 30 mm M10x1	M5	ORCHESTRALE D27105000	ETNICA - PHONICA
4	1501007	ø 30 mm M10x1	M5	WEGA WY27105000	AIRY - ATLAS - COLOSSEUM - COMBI NOVA - ESPRESSA - START
5	1501561	ø 30 mm M10x1	---	BEZZERA 7479941	GALATEA - GALATEA DOMUS - GIULIA - UNICA
5	1501561	ø 30 mm M10x1	---	BFC 0520070	CLASSICA - DELUX - GALILEO - IMOLA - JUNIOR - LA VITTORIA
5	1501561	ø 30 mm M10x1	---	BIANCHI 43051216	LUCIA - SARA - SOFIA
5	1501561	ø 30 mm M10x1	---	BRASILIA 04089.0.00.04	GRADISCA
5	1501561	ø 30 mm M10x1	---	ECM C229901128	GIOTTO - LAURA - VENEZIANO



Photo	LF Code	Dimensions	Hole	Suitable for	For machine model
5	1501561	ø 30 mm M10x1	---	ECM MANUFACTURE C229901128	CLASSIKA II - ELEKTRONIKA II PROFI - ELEKTRONIKA II PROFI
5	1501561	ø 30 mm M10x1	---	EXPOBAR CTAV1-11	EB61 - OFFICE
5	1501561	ø 30 mm M10x1	---	FAEMA	E61
5	1501561	ø 30 mm M10x1	---	FIAMMA RST 5.0.025.0009	ATLANTIC - MARINA - PRESTIGE
5	1501561	ø 30 mm M10x1	---	FIORENZATO C.S A2200170	BRICOLETTA - COLOMBINA - DUCALE - FENICE - LIDO - VOLANTE
5	1501561	ø 30 mm M10x1	---	FUTURMAT 02012904	ARIETE - CUSTOM - F3 - RIMINI
5	1501561	ø 30 mm M10x1	---	GAGGIA SPAGNA 02012904	BELLA - G6 - KB
5	1501561	ø 30 mm M10x1	---	GRIMAC 1201300006-GR762	ECLISSE - MIA - TEN - TWENTY - ZOLA I - ZOLA II
5	1501561	ø 30 mm M10x1	---	ITALCREM 02012904	IT4
5	1501561	ø 30 mm M10x1	---	MAIRALI 02012904	ARIANNE
5	1501561	ø 30 mm M10x1	---	PAVONI	BART
5	1501561	ø 30 mm M10x1	---	PROMAC 80230080	COMPACT - GREEN
5	1501561	ø 30 mm M10x1	---	RENEKA AT7479941	AMICI - ATALANTE
5	1501561	ø 30 mm M10x1	---	ROYAL 0520070	DIADEMA - SYNCHRO
5	1501561	ø 30 mm M10x1	---	SAB TM-SPR8F400	ELLIPSE - E96 - MODERNA
5	1501561	ø 30 mm M10x1	---	SANREMO 10052141	AMALFI - CAPRI - MILANO LX - PISA - TORINO - TREVISO
5	1501561	ø 30 mm M10x1	---	SCALA C-0318	BUTTERFLY - CARMEN - EROICA
5	1501561	ø 30 mm M10x1	---	VFA	ELITE - MAGESTIC - SPLENDOR
5	1501561	ø 30 mm M10x1	---	VIBIEMME RACCSPGR	CHIMAERA - DOMOBAR - DOSAPLUS - MERCURY - REPLICA
5	1501561	ø 30 mm M10x1	---	VISACREM 02012904	BRAVA - V6
5	1501561	ø 30 mm M10x1	---	WEGA WY27105	AIRY - ATLAS - ATLAS10 - NOVA - NOVECENTO - ORION ECO - P
6	1501568	ø 30 mm M10x1	M5	PAVONI 314098	P UNO - P TRE
6	1501014	ø 30 mm M9.6x1	M5	BRUGNETTI/AURORA 000183	ALEXIA - C

## CONTROL BOXES ROYAL



1

Photo	LF Code	For machines with no. of groups	Power	Suitable for	For machine model
1	5055048	1-2-3	230V	ROYAL 5030100	SYNCHRO

## DETERGENTS LF



1



2



3



4



5



6

Photo	LF Code	Description	Notes
1	3092143	DETERGENT COFFEE CLEAN	900 g
1	3092543	DETERGENT COFFEE CLEAN	500 g
2	3092350	DETERGENT COFFEE CLEAN	60 TABS 2.5 g
3	3092351	DETERGENT COFFEE CLEAN	15 BAGS 20 g
4	3092355	DETERGENT CAPPUCCINO PERFECT	1 L
5	3092352	SCALE REMOVER SCALE CLEAN	1 Kg
6	3092353	SCALE REMOVER SCALE CLEAN	12 BAGS 25 g



**DRAIN PIPES ELISPIR**



Photo	LF Code	∅ (mm)	Length (mm)	Sold per meter
1	1449270	12x18	30	---
1	1449670	12x18	5	---
1	1449271	14x20	30	---
1	1449671	14x20	5	---
1	1449272	16x23	30	---
1	1449672	16x23	5	---
1	1449273	18x25	30	---
1	1449673	18x25	5	---
1	1449274	20x27	30	---
1	1449674	20x27	5	---
1	1449255	25x33	---	Yes
1	1449256	30x38	---	Yes
1	5020932	35x44	---	Yes
2	1449104	3/4"M	---	---
3	1449876	3/4"M	1.5	---

**DRAIN TANKS ROYAL**



Photo	LF Code	Notes	Suitable for	For machine model
1	1527511	78x68 mm - ∅ 15 mm	ROYAL 4008005	DIADEMA - SYNCHRO

**EPDM FLAT GASKETS**



LF Code	Dimensions	Suitable for	Notes
1186427	∅ 10x4x2 mm	RANCILIO	FOR BREW GROUPS - PER GRUPPI EROGAZIONE
1186758	∅ 10x4.5x4 mm	MARCFI-ANCAS	FOR INLET TAPS - PER RUBINETTI CARICO
1186342	∅ 11x3x4 mm	CIMBALI - FAEMA	FOR STEAM/WATER TAPS - PER RUBINETTI VAPORE/ACQUA
1186454	∅ 11x3.6x2 mm	PROMAC - RANCILIO	FOR INLET TAPS - PER RUBINETTI CARICO
1186423	∅ 11x4x4 mm	BRASILIA	FOR INLET TAPS - PER RUBINETTI CARICO



LF Code	Dimensions	Suitable for	Notes
1186703	∅ 11x7x7 mm	CIMBALI	FOR BREW GROUPS M15- PER GRUPPI EROGAZIONE M15
1186083	∅ 12x3x4 mm	RENEKA	FOR STEAM/WATER TAPS - PER RUBINETTI VAPORE/ACQUA
1786263	∅ 12.5x8x9 mm	ASTORIA/CMA - WEGA	FOR STEAM/WATER TAPS - PER RUBINETTI VAPORE/ACQUA
1186588	∅ 13x3x4 mm	AZKOYEN	FOR STEAM/WATER TAPS - PER RUBINETTI VAPORE/ACQUA
1186161	∅ 13x4x4 mm	BRASILIA - CONTI - RENEKA	FOR STEAM/WATER TAPS - PER RUBINETTI VAPORE/ACQUA
1186935	∅ 13x4x4 mm	ELEKTRA	FOR STEAM/WATER TAPS - PER RUBINETTI VAPORE/ACQUA
1186935	∅ 13x4x4 mm	GRIMAC	FOR BREW GROUPS - PER GRUPPI EROGAZIONE
1186150	∅ 13x7.4x7 mm	SAN MARCO	FOR INLET TAPS - PER RUBINETTI CARICO
1186111	∅ 14x4x4 mm	BEZZERA	FOR STEAM/WATER TAPS - PER RUBINETTI VAPORE/ACQUA
1186111	∅ 14x4x4 mm	SAN MARCO	FOR BREW GROUPS - PER GRUPPI EROGAZIONE
1186302	∅ 14x4x5 mm	CARIMALI	FOR STEAM/WATER TAPS - PER RUBINETTI VAPORE/ACQUA
1186316	∅ 15x4x4 mm 60SH	ASTORIA/CMA - WEGA	FOR STEAM/WATER TAPS - PER RUBINETTI VAPORE/ACQUA
1186527	∅ 15x4x4 mm 80SH	ASTORIA/CMA - WEGA	FOR STEAM/WATER TAPS - PER RUBINETTI VAPORE/ACQUA
1186515	∅ 15x5.5x3.5 mm	SPAZIALE	FOR STEAM/WATER TAPS - PER RUBINETTI VAPORE/ACQUA
1186369	∅ 15x5.5x4 mm	FUTURMAT	FOR BREW GROUPS - PER GRUPPI EROGAZIONE
1186369	∅ 15x5.5x4 mm	SAN MARCO	FOR STEAM/WATER TAPS - PER RUBINETTI VAPORE/ACQUA
1186985	∅ 15x6x6 mm	GAGGIA	FOR STEAM/WATER TAPS - PER RUBINETTI VAPORE/ACQUA
1186985	∅ 15x6x6 mm	PAVONI	FOR STEAM/WATER TAPS - PER RUBINETTI VAPORE/ACQUA
1186300	∅ 15x7.3x4 mm	CIMBALI	FOR STEAM/WATER TAPS - PER RUBINETTI VAPORE/ACQUA
1186300	∅ 15x7.3x4 mm	GRIMAC	FOR STEAM/WATER TAPS - PER RUBINETTI VAPORE/ACQUA
1186057	∅ 15.3x7.7x4 mm	BRASILIA	FOR STEAM/WATER TAPS - PER RUBINETTI VAPORE/ACQUA
1186312	∅ 15.5x7.5x4 mm	MANY BRANDS - MOLTI MARCHI	SEVERAL APPLICATIONS - MOLTE APPLICAZIONI
1186233	∅ 16x4x5 mm	UNIC	FOR STEAM/WATER TAPS - PER RUBINETTI VAPORE/ACQUA
1186282	∅ 16.5x6x4 mm	SAN MARCO	FOR BREW GROUPS - PER GRUPPI EROGAZIONE
1186170	∅ 18x4x4 mm	CARIMALI	FOR STEAM/WATER TAPS - PER RUBINETTI VAPORE/ACQUA
3449039	∅ 18x11x2 mm	---	FOR INLET HOSES ∅ 1/2" - PER TUBI CARICO ∅ 1/2"
1186102	∅ 19x3.5x4 mm	BEZZERA	FOR STEAM/WATER TAPS - PER RUBINETTI VAPORE/ACQUA
1186958	∅ 20.5x15x2 mm	CIMBALI	FOR STEAM/WATER TAPS - PER RUBINETTI VAPORE/ACQUA
1186066	∅ 21x15x3 mm	BRASILIA	FOR STEAM/WATER TAPS - PER RUBINETTI VAPORE/ACQUA
1186410	∅ 21x16x2 mm	RANCILIO	FOR BREW GROUPS - PER GRUPPI EROGAZIONE
1186410	∅ 21x16x2 mm	RENEKA	FOR STEAM/WATER TAPS - PER RUBINETTI VAPORE/ACQUA
1786222	∅ 22x18x1.5 mm	CIMBALI	FOR BOOSTER PUMPS - PER POMPE VOLUMETRICHE
3449026	∅ 24x12x2 mm	---	FOR INLET HOSES ∅ 3/4" - PER TUBI CARICO ∅ 3/4"
1786231	∅ 24x15x3 mm	GAGGIA	FOR INLET TAPS - PER RUBINETTI CARICO
1786231	∅ 24x15x3 mm	PAVONI	FOR STEAM/WATER TAPS - PER RUBINETTI VAPORE/ACQUA
1786315	∅ 51.3x43x5 mm	ISOMAC	FOR BREW GROUPS - PER GRUPPI EROGAZIONE

## EXPANSION AND NON-RETURN VALVES "UNIVERSAL"



Photo	LF Code	Dimensions
1	1523036	∅ 1/8"M-1/8"F
2	1523700	∅ 1/8"M-1/8"M
3	3349281	∅ 3/8"F-3/8"F
4	3349283	∅ 3/4"F-3/4"F
5	1523072	∅ 3/8"M



**FILTER HOLDER GASKETS ROYAL**



1

Photo	LF Code	Dimensions (mm)	Notes	Suitable for	For machine model
1	1186891	ø 73x57x8	---	ROYAL 0520090	DIADEMA - SYNCHRO

**FILTER HOLDER ROYAL**



Photo	LF Code	Wings	Knob	Spouts	Filter	Spring	Suitable for	For machine model
1	1165300	6.3 mm	M12	3/8	7 gr	YES	ROYAL	ALL MODELS - TUTTI I MODELLI
2	1165301	6.3 mm	M12	3/8	14 gr	YES	ROYAL	ALL MODELS - TUTTI I MODELLI
3	1165061	6.3 mm	M12	3/8	NO	NO	ROYAL 4650100	ALL MODELS - TUTTI I MODELLI
4	1165064	6.3 mm	M12	3/8	NO	NO	ROYAL 4650108	ALL MODELS - TUTTI I MODELLI

**FILTER LOCKING SPRING**

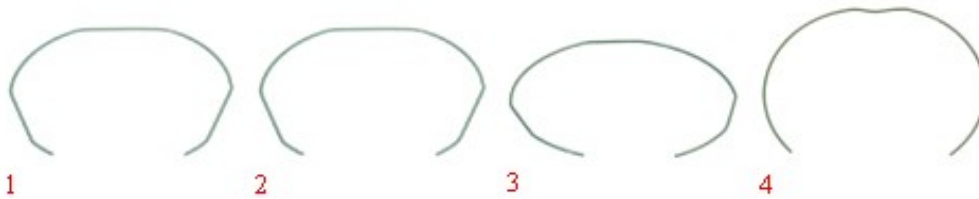
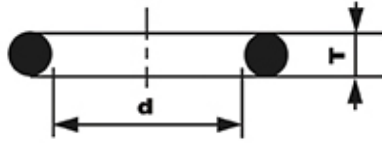

Photo	LF Code	wire ø (mm)	Suitable for
1	1250101	1.00	ALL BRANDS - TUTTI I MARCHI
1	1250002	1.20	ALL BRANDS - TUTTI I MARCHI
1	1250333	1.30	ALL BRANDS - TUTTI I MARCHI
1	1250338	1.40	ALL BRANDS - TUTTI I MARCHI
2	1250279	1.40	ASTORIA/CMA P4Y - WEGA CONCEPT 52
3	5033397	1.00	PAVONI EUROPICCOLA
4	1250018	1.00	ELEKTRA MICROCASA



## GASKETS "OR" R1-R2-R3....R10..

**1.90 - 2.20**  
**2.70 - 3.60 mm**



Dimensions (mm) T x d	Model (new cross-references)	Model (old cross-references)	LF Code (EPDM)	LF Code (VITON)	LF Code (SILICONE)
1.90 x 2.40	OR R0		1786108		
1.90 x 3.40	OR R2		2104557		
1.90 x 4.20	OR R3		1186996	1786316	
1.90 x 4.90	OR R4		1786286		
1.90 x 5.70	OR R5		1186854	1786310	1186610
1.90 x 7.20	OR R6		1186556	1186791	
2.70 x 12.10	OR R10		1786297		
3.60 x 23.00	OR R18		1786157		

## GASKETS FOR GROUP ADJUSTABLE TO SEVERAL BRANDS

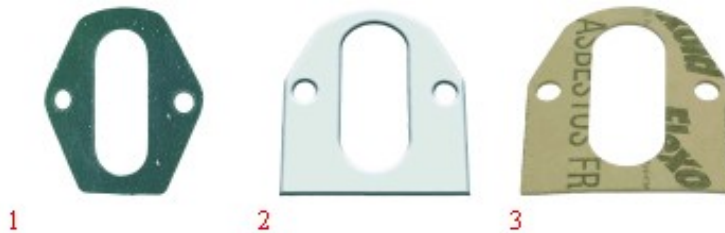

Photo	LF Code	Features	Suitable for	For machine model
1	1186502	79x71x2 mm - CARBO	MANY BRANDS - MOLTI MARCHI	FOR MODEL E61 GROUPS - PER GRUPPI TIPO E61
2	1186508	77x73x2 mm - PTFE	MANY BRANDS - MOLTI MARCHI	FOR MODEL E61 GROUPS - PER GRUPPI TIPO E61
3	1186384	80x70x2 mm - PAPER	MANY BRANDS - MOLTI MARCHI	FOR MODEL E61 GROUPS - PER GRUPPI TIPO E61

## GASKETS FOR HEATING ELEMENTS



Photo	LF Code	Dimensions	Material	For heating elements
1	3060608	OR 03050	EPDM	1/4"
1	3186175	∅ 51x41x3.5 mm	EPDM	1"1/4
2	1186623	∅ 53x43x3 mm	PTFE	1"1/4
3	1186633	∅ 53x42x3 mm	CARBO	1"1/4
4	3186010	∅ 54x42x2 mm	ESENTE	1"1/4
2	1186993	∅ 42x33x3 mm	PTFE	1"
3	1186627	∅ 41x33x3 mm	CARBO	1"
2	1186179	∅ 57x43x3 mm	PTFE	TYPE FAEMA - TIPO FAEMA



# ROYAL



Photo	LF Code	Dimensions	Material	For heating elements
3	1186606	∅ 57x43x3 mm	CARBO	TYPE FAEMA - TIPO FAEMA
2	1186608	∅ 50x40x2 mm	PTFE	ASTORIA/CMA - GAGGIA - SAN MARCO
3	1786215	∅ 50x40x2 mm	CARBO	ASTORIA/CMA - GAGGIA - SAN MARCO
4	1186156	∅ 50x40x2 mm	ESENTE	ASTORIA/CMA - GAGGIA - SAN MARCO
1	1186152	OR 03287	EPDM	BEZZERA BZ02 - BZ07 - BZ10 - BZ99
1	3186013	OR 06187	EPDM	CASADIO VENTI
3	1186607	∅ 57.8x50x3 mm	CARBO	CASADIO - CIMBALI
2	1186609	∅ 58x51x2 mm	PTFE	CIMBALI - CASADIO
2	1186155	∅ 76x68.4x3 mm	PTFE	CONTI
2	1186979	∅ 52x40x2 mm	PTFE	EXPOBAR - MARZOCCO - QUICK MILL
1	1186641	OR 0176	EPDM	GAGGIA G105 - G106 - PAVONI EUROPICCOLA
1	1186798	OR 0146	VITON	GAGGIA GE ONE - GD ONE
2	1186409	∅ 68x55x3 mm	PTFE	NUOVA SIMONELLI - VICTORIA ARDUINO
3	1186638	∅ 67x55x3 mm	CARBO	NUOVA SIMONELLI - VICTORIA ARDUINO
2	1186455	∅ 65x47x1.5 mm	PTFE	RANCILIO - RANCILIO
3	3186011	∅ 63x48x2 mm	CARBO	RANCILIO - RANCILIO
1	3186290	OR 04187	EPDM	RENEKA
3	1186637	∅ 56x47x3 mm	CARBO	SAN MARCO
2	1186516	∅ 26x17x2 mm	PTFE	SPAZIALE S1
1	1186705	OR 03168	VITON	SPAZIALE S1
2	1186639	∅ 62x51x2 mm	PTFE	SPAZIALE
1	1186715	OR 0159	VITON	SPAZIALE
4	1186636	∅ 62x51x2 mm	ESENTE	SPAZIALE
1	1186241	OR 04262	VITON	UNIC

## HANDLES ROYAL



Photo	LF Code	Notes	Suitable for	For machine model
1	1241321	STEAM/WATER - VAPORE/ACQUA	ROYAL 4001010	DIADEMA - SYNCHRO
2	1241322	STEAM - VAPORE	ROYAL 4001020	DIADEMA - SYNCHRO
3	1241045	WATER - ACQUA	ROYAL 4001025	DIADEMA - SYNCHRO
4	1241401	FOR BREW GROUPS - PER GRUPPI EROGAZIONE	ROYAL 4001005	DIADEMA - SYNCHRO

## HEATING ELEMENTS ROYAL

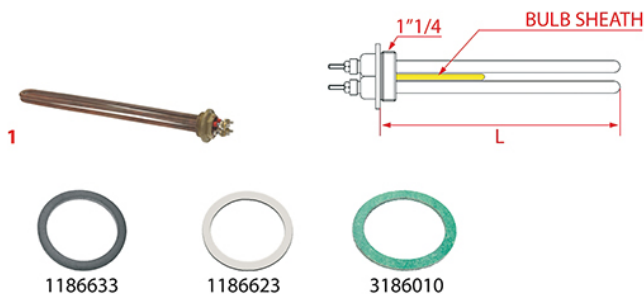

Photo	LF Code	Watt - Volt	L (mm)	Groups	Bulb sheath	Suitable for	For machine model
1	1755208	3300W 230V	370	2	YES	ROYAL 5050220	---
1	1755209	4000W 230V	495	3	YES	ROYAL 5050230	---



## HEATING ELEMENTS ROYAL

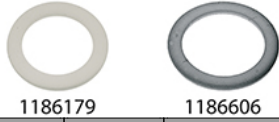
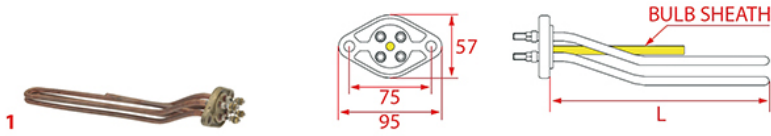

Photo	LF Code	Watt - Volt	L (mm)	Groups	Bulb sheath	Suitable for	For machine model
1	1755210	3500W 230V	340	2	YES	ROYAL 5050720	DIADEMA - SYNCHRO
1	1755211	5200W 230V	510	3	YES	ROYAL 5050730	DIADEMA - SYNCHRO

## LEVEL GLASS BALLS



Photo	LF Code	Dimensions (mm)	Suitable for
1	1323006	∅ 7	ALL BRANDS - TUTTE LE MARCHE
2	1323001	∅ 5.8	ALL BRANDS - TUTTE LE MARCHE
3	1323007	∅ 9,5	ALL BRANDS - TUTTE LE MARCHE

## LEVEL GLASS GASKETS



Photo	LF Code	Dimensions (mm)	Suitable for
1	1186173	∅ 16.5x10x12.5	MARCFI-ANCAS
1	1186221	∅ 19x11.5x10	CARIMALI - CONTI - NUOVA SIMONELLI
2	1186270	∅ 18x11x4	CONTI
2	1186227	∅ 21x11.5x5	BRUGNETTI/AURORA - FAEMA - FUTURMAT
2	1186251	∅ 18x12x3	RANCILIO
2	1186360	∅ 18x12x2	CIMBALI
3	1401002	∅ 14.5x10x7	BEZZERA
4	1186206	∅ 16x10x8	ASTORIA/CMA - BFC - GRIMAC - NUOVA SIMONELLI - ROYAL
5	1186375	∅ 15x9x8	ELEKTRA
5	1186469	∅ 15x9x5	GAGGIA - PAVONI
6	1186498	∅ 14.5x11x2	EXPOBAR
6	1186256	∅ 31x19x3	SAN MARCO
6	1186266	∅ 26x12x7	UNIC



## LEVEL PROBES ROYAL



1

Photo	LF Code	Notes	Suitable for	For machine model
1	7105438	∅ 1/4"M-165 mm	ROYAL 4550005	DIADEMA - SYNCHRO

## MICROSWITCHES ROYAL



1

Photo	LF Code	Volt	Suitable for	For machine model
1	1240841	15A 250V	ROYAL 5003310	DIADEMA - SYNCHRO

## NBR FLAT GASKETS



1



2

Photo	LF Code	Dimensions	Suitable for	Notes
1	1186474	∅ 12x7x5 mm	GAGGIA	FOR STEAM/WATER TAPS - PER RUBINETTI VAPORE/ACQUA
1	1186474	∅ 12x7x5 mm	PAVONI	FOR STEAM/WATER TAPS - PER RUBINETTI VAPORE/ACQUA
2	1186311	∅ 13x4x4 mm	MANY BRANDS - MOLTI MARCHI	SEVERAL APPLICATIONS - MOLTE APPLICAZIONI

## NOZZLES ROYAL



1

Photo	LF Code	Notes	Suitable for	For machine model
1	1501541	M6x1 - $\varnothing$ 0.8 mm	ROYAL 0520020	DIADEMA - SYNCHRO

## O-RING GASKETS THICKNESS 2.62 mm

# 2.62 mm

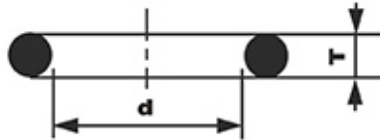

Dimensions (mm) T x d	Model (new cross-references)	Model (old cross-references)	LF Code	LF Code	LF Code	LF Code	LF Code
			(EPDM)	(VITON) STANDARD	(SILICONE) RED	(VITON) MIX COLOR	(SILICONE) MIX COLOR
2.62 x 6.02	OR 03024		3786668		1786137		
2.62 x 7.59	OR 03030		1186358	1786155	1786280	1786197	
2.62 x 9.13	OR 0109	OR 0109	1186255	5029740	1186910		3186608
2.62 x 9.19	OR 03037	OR 0111	3186340	1786202			
2.62 x 9.92	OR 0112	OR 0112	1186304		1786049	1186879	1186914
2.62 x 10.78	OR 03043	OR 0113	1186318		3786719	1186236	
2.62 x 11.91	OR 0115	OR 0115	1186805	1186709	1186745		
2.62 x 12.37	OR 03050	OR 0116	3060608	3090132	1186458		
2.62 x 13.10	OR 0117	OR 0117	3243086		1186085		1786234
2.62 x 13.95	OR 03056	OR 0118	3186860		1186762		
2.62 x 15.08	OR 0119	OR 0119	1186414	1186714	3523062		
2.62 x 15.88	OR 0121	OR 0121	3186434	1186246			
2.62 x 17.13	OR 03068	OR 0122	3186181	1786276	1186850		
2.62 x 17.86	OR 0123	OR 0123	3186287		1186000		1199001
2.62 x 18.72	OR 03075	OR 0124	1186356		5059295		
2.62 x 20.24	OR 03081	OR 0127	1186327	5039864	1186026		1186053
2.62 x 20.63	OR 0128	OR 0128	3186183	1186591		1786300	
2.62 x 21.89	OR 03087		1786233		1186796		
2.62 x 22.22	OR 0130	OR 0130	3186253		1186292		
2.62 x 23.47	OR 03093		1186922				
2.62 x 23.81	OR 0132	OR 0132	1186438				
2.62 x 25.07	OR 03100		1186833				
2.62 x 26.65	OR 03106		1186759			5045475	1786243
2.62 x 28.25	OR 03112		3186247	5037072			7104228
2.62 x 29.82	OR 03118		3186458				
2.62 x 31.42	OR 03125		3186244			1186930	
2.62 x 32.99	OR 03131		3186847	5029479	1186920		
2.62 x 34.60	OR 03137		3243250	1186767			
2.62 x 36.14	OR 03143		5027619				
2.62 x 39.34	OR 03156		3786183	1186184			
2.62 x 40.95	OR 03162		3243389				



# ROYAL



Dimensions (mm) T x d	Model (new cross-references)	Model (old cross-references)	LF Code	LF Code	LF Code	LF Code	LF Code
			(EPDM)	(VITON) STANDARD	(SILICONE) RED	(VITON) MIX COLOR	(SILICONE) MIX COLOR
2.62 x 42.52	OR 03168		3160040	1186705			
2.62 x 45.69	OR 03181		1186466				
2.62 x 47.30	OR 03187		3160044		1786313		
2.62 x 48.89	OR 03193		1186672	5055114			
2.62 x 50.47	OR 03200		3186245	5034849		1186948	
2.62 x 53.65	OR 03212		3060038		1186847		
2.62 x 58.42	OR 03231		3186455		1199075		
2.62 x 60.00	OR 03237		3243166				
2.62 x 61.60	OR 03243		3122252				
2.62 x 63.17	OR 03250		3186315				
2.62 x 64.77	OR 03256		1786203	1786153			
2.62 x 67.95	OR 03268		3186248				
2.62 x 71.12	OR 03281		1186625		1186405		
2.62 x 72.69	OR 03287		1186152				
2.62 x 75.87	OR 03300		1186237	1186779			
2.62 x 78.94			3786579				
2.62 x 88.57	OR 03350		5015751		1786124		
2.62 x 94.92	OR 03375		1186605				
2.62 x 215.57	OR 03850		3786202				

## O-RING GASKETS THICKNESS 3.53 mm

3.53 mm

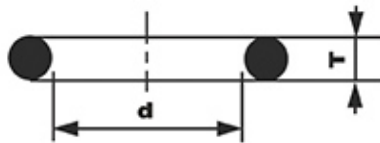

Dimensions (mm) T x d	Model (new cross-references)	Model (old cross-references)	LF Code	LF Code	LF Code	LF Code	LF Code
			(EPDM)	(VITON) STANDARD	(SILICONE) RED	(VITON) MIX COLOR	(SILICONE) MIX COLOR
3.53 x 9.12	OR 04036		6456047	2102713			
3.53 x 15.47	OR 04061		1186019		3786053		
3.53 x 17.04	OR 04067		3786519				
3.53 x 18.64	OR 04075	OR 0125	1186472	1186766	3186610		
3.53 x 20.22	OR 04081	OR 0126	1186238	2111463	1186009		
3.53 x 21.82	OR 04087	OR 0129	1186630	4059475			
3.53 x 23.40	OR 04093	OR 0131	3186143	5028161	1786050		
3.53 x 26.58	OR 04106	OR 0135	1186231		1786119		
3.53 x 28.17	OR 04112	OR 0136	1186480	3786008	1786018		1186869
3.53 x 29.75	OR 04118	OR 0137	3243142	1786167	1186874	1186790	1786199
3.53 x 31.34	OR 04125	OR 0138	1186506		1186010		
3.53 x 32.93	OR 04131	OR 0139	1186655	3186580	1786210	1786098	
3.53 x 34.52	OR 04137	OR 0140	3061040		1186990	1186403	1186963
3.53 x 36.10	OR 04143	OR 0141	3186338		1786118		
3.53 x 37.69	OR 04150	OR 0142	3186197	5034986	1186905		1786168
3.53 x 39.69	OR 0144	OR 0144	3186606		1786099		1186947
3.53 x 40.86	OR 04162		3067198	40C6450	5039021		
3.53 x 41.28	OR 0146	OR 0146	3186238	1186798			
3.53 x 42.86	OR 0147	OR 0147	3186184	1786117	1786140		
3.53 x 44.04	OR 04175		3186175	1786152			
3.53 x 46.04	OR 0150	OR 0150	3786181				
3.53 x 47.22	OR 04187		3186290	1186190			
3.53 x 47.63	OR 0152	OR 0152	1186087			1186931	
3.53 x 49.21	OR 0153	OR 0153	3786454	5005318	1786116		



Dimensions (mm) T x d	Model (new cross-references)	Model (old cross-references)	LF Code	LF Code	LF Code	LF Code	LF Code
			(EPDM)	(VITON) STANDARD	(SILICONE) RED	(VITON) MIX COLOR	(SILICONE) MIX COLOR
3.53 x 50.39	OR 04200		3186601	3786459	4006406		
3.53 x 50.80	OR 0155	OR 0155	3316031		1186503	1786311	
3.53 x 53.57	OR 04212		1186643			5501390	
3.53 x 55.56	OR 0159	OR 0159	3186697	1186715			
3.53 x 56.74	OR 04225		1186799				
3.53 x 57.15	OR 0161	OR 0161	1186198	1786292			
3.53 x 58.74	OR 0162	OR 0162	1186199	1786287			
3.53 x 59.92	OR 04237		3316110				
3.53 x 60.33	OR 0164	OR 0164	1186230	1786011			
3.53 x 63.09	OR 04250		1186022				
3.53 x 63.50	OR 0167	OR 0167	3186454		1786298		
3.53 x 65.09	OR 0168	OR 0168	1186645				
3.53 x 68.26	OR 0171	OR 0171	1186763				
3.53 x 69.44	OR 04275		5022973		1786209		
3.53 x 71.44	OR 0174	OR 0174	3243160				
3.53 x 73.03	OR 0176	OR 0176	1186641		1186858	1786254	
3.53 x 75.80	OR 04300		1186748		1786110		
3.53 x 78.97	OR 04312		3186271	1186698	1786268		
3.53 x 82.14	OR 04325		1186693				
3.53 x 85.32	OR 04337		1186519				
3.53 x 88.50	OR 04350		1186873				1786261
3.53 x 91.67	OR 04362		3061007				
3.53 x 94.84	OR 04375		3061011				
3.53 x 98.02	OR 04387		3186137				
3.53 x 101.20	OR 04400		3160607	5501389	1786129		
3.53 x 107.50	OR 04425		3186235			1786214	
3.53 x 110.70	OR 04437		3061016				
3.53 x 113.90	OR 04450		3186456				
3.53 x 120.20	OR 04475		3186466		1186806		
3.53 x 132.90	OR 04525		1186941				
3.53 x 136.10	OR 04537		1186708				
3.53 x 148.80	OR 04587		3122552				
3.53 x 158.30	OR 04625		3122255				
3.53 x 164.70	OR 04650		3122344				
3.53 x 183.70	OR 04725		3061037				

## O-RING GASKETS THICKNESS 5.34 mm

5.34 mm

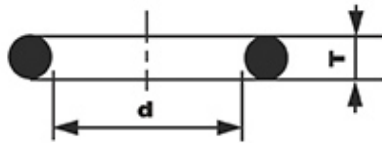

Dimensions (mm) T x d	Model (new cross-references)	Model (old cross-references)	LF Code	LF Code	LF Code	LF Code	LF Code
			(EPDM)	(VITON) STANDARD	(SILICONE) RED	(VITON) MIX COLOR	(SILICONE) MIX COLOR
5.34 x 34.29	OR 06135		1186220				
5.34 x 37.47	OR 06150	OR 0143	3186001			5018795	
5.34 x 40.65	OR 06162	OR 0145	5026454	1786272			
5.34 x 43.82	OR 06175	OR 0148	3186339		5039034		
5.34 x 47.00	OR 06187	OR 0151	3186013	5060790	3186313		
5.34 x 50.16	OR 06200	OR 0154	3186333		1786275		
5.34 x 53.34	OR 06212	OR 0157	1186673	3186241	1786273		5023642
5.34 x 56.52	OR 06225	OR 0160	3186014				3186314



Dimensions (mm) T x d	Model (new cross-references)	Model (old cross-references)	LF Code (EPDM)	LF Code (VITON) STANDARD	LF Code (SILICONE) RED	LF Code (VITON) MIX COLOR	LF Code (SILICONE) MIX COLOR
5.34 x 59.69	OR 06237	OR 0163	1186932		5038239		
5.34 x 62.87	OR 06250	OR 0166	3186331				
5.34 x 66.04	OR 06262	OR 0169	1186505				
5.34 x 69.22	OR 06275	OR 0172	3160061				
5.34 x 72.39	OR 06287	OR 0175	3786685				
5.34 x 74.63	OR 0178	OR 0178	3186015		1786009		
5.34 x 75.57	OR 06300	OR 0179	5039882	1186456			
5.34 x 78.74	OR 06312	OR 0180	3010048				
5.34 x 79.77	OR 0181	OR 0181	5006335				
5.34 x 81.92	OR 06325	OR 0182	3243088				
5.34 x 85.09	OR 06337	OR 0183	3186335		1786246		
5.34 x 94.62	OR 06375	OR 0187	1786002				
5.34 x 100.00	OR 0189	OR 0189	1186749				
5.34 x 110.50	OR 06437	OR 0194	5010476				1186075
5.34 x 120.70	OR 0201	OR 0201	3160615				
5.34 x 139.70	OR 0215	OR 0215	5052966				

**O-RING GASKETS THICKNESS 7.00 mm**

**7.00 mm**

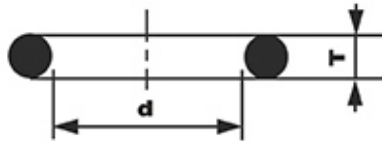

Dimensions (mm) T x d	Model (new cross-references)	Model (old cross-references)	LF Code (EPDM)	LF Code (VITON) STANDARD	LF Code (SILICONE) RED	LF Code (VITON) MIX COLOR	LF Code (SILICONE) MIX COLOR
7.00 x 135.90	OR 08537	OR 0212	5050109				
7.00 x 142.20	OR 08562	OR 0216	2104555				
7.00 x 155.60	OR 0223	OR 0223	5006513				
7.00 x 183.52	OR 08725	OR 0234	5024838				
7.00 x 204.67	OR 08950	OR 0246	5026360		5029810		
7.00 x 266.07	OR 081050	OR 0250	5034088				
7.00 x 297.80	OR 081175	OR 0255	5032360				

**O-RING THICKNESS 1.78 mm**

**1.78 mm**

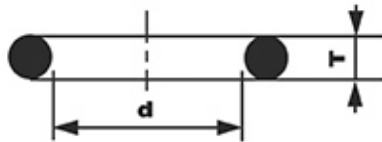

Dimensions (mm) T x d	Model (new cross-references)	Model (old cross-references)	LF Code (EPDM)	LF Code (VITON) STANDARD	LF Code (SILICONE) RED	LF Code (VITON) MIX COLOR	LF Code (SILICONE) MIX COLOR
1.78 x 1.78	OR 02007		2111723				
1.78 x 2.57	OR 02010		1186163	1186746			
1.78 x 2.90	OR 02012	OR 0101	1186365		1186846	1186842	
1.78 x 3.69	OR 02015	OR 0102	1186014	1186900	1786278	1786095	1186514
1.78 x 4.48	OR 02018	OR 0103	1186421	1186755	1186861		





Dimensions (mm) T x d	Model (new cross-references)	Model (old cross-references)	LF Code	LF Code	LF Code	LF Code	LF Code
			(EPDM)	(VITON) STANDARD	(SILICONE) RED	(VITON) MIX COLOR	(SILICONE) MIX COLOR
1.78 x 5.28	OR 02021	OR 0104	1186362	1786088	1186903	1786144	5056235
1.78 x 6.07	OR 02025	OR 0105	3243139	1186612	1186611	1786143	1486013
1.78 x 6.75	OR 0106	OR 0106	3243009	1186435	1186864		
1.78 x 7.66	OR 02031	OR 0107	1186411	1186717	1186901	1786085	
1.78 x 8.73	OR 0108	OR 0108	1186422	1186707	1186902		
1.78 x 9.25	OR 02037	OR 0110	1186803	1186088	1786087	1786267	
1.78 x 10.82	OR 02043		1186346	1786303	5008673	1186950	
1.78 x 11.11	OR 0114	OR 0114	1186626	1186730	1186877		1786075
1.78 x 12.42	OR 02050		1186352		1186366		
1.78 x 14.00	OR 02056		1186223	1786154	1786061	5037375	
1.78 x 15.60	OR 02062		1186424	1786232	1786159	1786208	
1.78 x 17.17	OR 02068		3243069	1786271		1786165	
1.78 x 18.77	OR 02075		3186440			1186933	5008687
1.78 x 20.35	OR 02081		3243266				1186373
1.78 x 21.95	OR 02087		3243382	1786277			
1.78 x 23.52	OR 02093		1186401				
1.78 x 25.12	OR 02100		3186169				
1.78 x 26.70	OR 02106		3186343		1186863		
1.78 x 28.30	OR 02112		3186754	1186631			
1.78 x 29.87	OR 02118		5010533				
1.78 x 31.47	OR 02125		3243191	1186919	1786139		
1.78 x 33.05	OR 02131		1186003		3186317		
1.78 x 34.65	OR 02137		3243189		5060454	1186929	
1.78 x 47.35	OR 02187		7102065		3186657		
1.78 x 50.52	OR 02200		1186956				
1.78 x 60.05	OR 02237		6456037				
1.78 x 72.75	OR 02287		5059891				
1.78 x 75.92	OR 02300		1186397				
1.78 x 82.27	OR 02325		6456074				
1.78 x 88.62	OR 02350		3186232				
1.78 x 94.97	OR 02375		3122121				
1.78 x 120.37	OR 02475		3122365				
1.78 x 133.07	OR 02525		3186239				

## PINS ROYAL



Photo	LF Code	Dimensions	Suitable for	Notes	For machine model
1	1324048	---	ROYAL 0530070	FOR BREW GROUPS - PER GRUPPI EROGAZIONE	DIADEMA - SYNCHRO
2	1349471	---	ROYAL 0540040	FOR STEAM/WATER TAPS - PER RUBINETTI VAPORE/ACQUA	DIADEMA - SYNCHRO
3	1324066	---	ROYAL 0540080	FOR STEAM/WATER TAPS - PER RUBINETTI VAPORE/ACQUA	DIADEMA - SYNCHRO



**PRECISION COFFEE FILTERS ROYAL**



Photo	LF Code	Model	Suitable for	Notes
1	1460100	1 CUP - 6/8 gr - H24.5	ROYAL	---
1	1460101	1 CUP - 7/9 gr - H26.5	ROYAL	---
2	1460102	2 CUPS - 12/18 gr - H24.5	ROYAL	---
2	1460103	2 CUPS - 14/20 gr - H26.5	ROYAL	---
3	1460104	3 CUPS - 18/22 gr - H28.5	ROYAL	---

Filtri progettati per ottenere la perfetta estrazione del caffè , acciaio Aisi 316 , certificati alimentare

**PRESSURE GAUGES ROYAL**

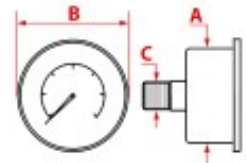

Photo	LF Code	Scale (bar)	Dimensions A - B - C (mm)	Suitable for	For machine model
1	1245043	0÷2.5/0÷15	63 - 70 - 1/8	ROYAL 4551014	DIADEMA
2	1245050	0÷3.0/0÷15	63 - 70 - 1/8	ROYAL 4551017	---

**PRESSURE SWITCHES PARKER**



Photo	LF Code	Model	Scale (bar)
1	1320541	PS325-1C - 3 POLES - 20A - 1/4"	0.5÷1.4

## PRESSURE SWITCHES SIRAI



Photo	LF Code	Model	Scale (bar)
1	1320531	P302/6 - 3 POLES - 30A - 1/4"	0.5÷1.4
2	1320533	P302/6	---
3	1320800	P203T01 - 2 POLES - 20A - 1/4"	0.5÷1.4
3	1320801	P203T02 - 2 POLES - 20A - 1/4"	0.9÷1.7
3	1320802	P303T01 - 3 POLES - 20A - 1/4"	0.5÷1.4
3	1320803	P303T02 - 3 POLES - 20A - 1/4"	0.9÷1.7

## PROTECTIVE RUBBERPIECES



Photo	LF Code	For pipe ø (mm)	Suitable for
1	1186398	8	NUOVA SIMONELLI
1	5030025	10	NUOVA SIMONELLI - SANREMO
2	1187501	8	ALL BRANDS - TUTTE LE MARCHE
2	1186924	10	CASADIO - CIMBALI - FAEMA - FIAMMA
3	1186180	10	ALL BRANDS - TUTTE LE MARCHE
4	1549009	8	ASTORIA/CMA - MCE - WEGA
5	1549011	10	CIMBALI - FAEMA

## PROTECTIVE RUBBERPIECES



Photo	LF Code	For pipe ø (mm)	Suitable for
1	1186339	8	ALL BRANDS - TUTTE LE MARCHE
1	1186080	10	ALL BRANDS - TUTTE LE MARCHE
2	1549020	10	GAGGIA
3	1187001	10	SPAZIALE
4	1449172	8	ASTORIA/CMA - ELEKTRA - MARZOCCO - WEGA
5	1649001	10	FRACINO
6	1649002	8	CARIMALI



## PTFE FLAT GASKETS



LF Code	Dimensions	Suitable for	Notes
5500622	∅ 6x1.8x2 mm	SAECO	FOR STEAM/WATER TAPS - PER RUBINETTI VAPORE/ACQUA
1186718	∅ 7x5x1 mm	SPAZIALE	FOR HIDRAULIC SYSTEM - PER IMPIANTO IDRAULICO
1186974	∅ 8.5x4.5x1.5 mm	CIMBALI - CASADIO	FOR MANOMETER - PER MANOMETRO
1786291	∅ 9.5x6x2 mm	VIBIEMME	FOR BREW GROUPS - PER GRUPPI EROGAZIONE
1186099	∅ 10x6x1 mm	BEZZERA - BIANCHI - BRASILIA	FOR BREW GROUPS - PER GRUPPI EROGAZIONE
1186099	∅ 10x6x1 mm	PAVONI - RENEKA	FOR BREW GROUPS - PER GRUPPI EROGAZIONE
1186434	∅ 10x7x0.5 mm	FAEMA	FOR BREW GROUPS - PER GRUPPI EROGAZIONE
1186359	∅ 11.4x8x3 mm	CIMBALI	FOR INLET TAPS - PER RUBINETTI CARICO
1186809	∅ 12x9x1 mm	FIAMMA - RANCILIO	FOR BREW GROUPS - PER GRUPPI EROGAZIONE
1186121	∅ 12x10x0.5 mm	FAEMA	FOR STEAM/WATER TAPS - PER RUBINETTI VAPORE/ACQUA
1186065	∅ 12x10x1 mm	BRASILIA - FIORENZATO - VIBIEMME	FOR STEAM/WATER TAPS - PER RUBINETTI VAPORE/ACQUA
1186908	∅ 12x10x2 mm	SAECO	---
1186581	∅ 13x3x4 mm	AZKOYEN	---
1186661	∅ 13x15.5x1 mm	BRASILIA	FOR STEAM/WATER TAPS - PER RUBINETTI VAPORE/ACQUA
1186945	∅ 14x10x1.5 mm	CIMBALI	FOR BOOSTER PUMPS - PER POMPE VOLUMETRICHE
1186794	∅ 14.6x12x3 mm	PROMAC	FOR STEAM/WATER TAPS - PER RUBINETTI VAPORE/ACQUA
1186189	∅ 15x11x2 mm	ASTORIA/CMA	FOR BREW GROUPS - PER GRUPPI EROGAZIONE
3186273	∅ 16.5x12.5x1.5 mm	---	---
1186240	∅ 17x12x0.5 mm	FAEMA	FOR BREW GROUPS - PER GRUPPI EROGAZIONE
1186468	∅ 17x12x1.5 mm	PAVONI - GAGGIA	---
1186982	∅ 17x13x2 mm	GRIMAC	FOR BOILER SAFETY VALVES - PER VALVOLA BOILER
1186982	∅ 17x13x2 mm	PAVONI	FOR BREW GROUPS - PER GRUPPI EROGAZIONE
1186982	∅ 17x13x2 mm	VIBIEMME	FOR LEVEL CAPS - PER TAPPO LIVELLO
1186079	∅ 17x13x3 mm	BRASILIA	FOR BREW GROUPS - PER GRUPPI EROGAZIONE
1186119	∅ 17.3x12x2 mm	CONTI	FOR BREW GROUPS - PER GRUPPI EROGAZIONE
1186030	∅ 18x3.5x1 mm	EXPOBAR	FOR BREW GROUPS - PER GRUPPI EROGAZIONE
1186443	∅ 18x9x0.5 mm	RANCILIO - PROMAC	FOR STEAM/WATER TAPS - PER RUBINETTI VAPORE/ACQUA
1186404	∅ 18x13x2 mm	MANY BRANDS - MOLTI MARCHI	SEVERAL APPLICATIONS - MOLTE APPLICAZIONI
1786301	∅ 18x13.5x2 mm	FIAMMA	---
1786166	∅ 18x14x1.5 mm	CIMBALI - CASADIO	FOR BOILER SAFETY VALVES - PER VALVOLA BOILER
1786040	∅ 18.2x13x2.5 mm	EXPOBAR	---
1786251	∅ 19x14.5x2 mm	CARIMALI	FOR BREW GROUPS - PER GRUPPI EROGAZIONE
1786001	∅ 20x13x3 mm	---	---
1186959	∅ 20x15x1 mm	CIMBALI - FAEMA	---
1186594	∅ 20x17x2 mm	BRASILIA	FOR INLET TAPS - PER RUBINETTI CARICO
1186594	∅ 20x17x2 mm	ORCHESTRALE	FOR STEAM/WATER TAPS - PER RUBINETTI VAPORE/ACQUA
1186594	∅ 20x17x2 mm	SANREMO	FOR BREW GROUPS - PER GRUPPI EROGAZIONE
1186201	∅ 21x16.8x2 mm	MANY BRANDS - MOLTI MARCHI	SEVERAL APPLICATIONS - MOLTE APPLICAZIONI
3786036	∅ 22x9x1 mm	---	---
1186326	∅ 22x16x2 mm	MANY BRANDS - MOLTI MARCHI	SEVERAL APPLICATIONS - MOLTE APPLICAZIONI
1186957	∅ 22x17x1.5 mm	CIMBALI - CASADIO	FOR STEAM/WATER TAPS - PER RUBINETTI VAPORE/ACQUA
1186314	∅ 22x17x2 mm	MANY BRANDS - MOLTI MARCHI	SEVERAL APPLICATIONS - MOLTE APPLICAZIONI
3186609	∅ 24x13x1.5 mm	---	---
1186323	∅ 24x18x2 mm	MANY BRANDS - MOLTI MARCHI	SEVERAL APPLICATIONS - MOLTE APPLICAZIONI
1186731	∅ 24x19x2 mm	FIORENZATO - MARZOCCO - VIBIEMME	FOR STEAM/WATER TAPS - PER RUBINETTI VAPORE/ACQUA
1786250	∅ 24x20x1.5 mm	CARIMALI	FOR BREW GROUPS - PER GRUPPI EROGAZIONE
3186278	∅ 25x16.5x0.5 mm	---	---



LF Code	Dimensions	Suitable for	Notes
1186969	∅ 25x21x1.5 mm	CIMBALI - CASADIO	FOR FILTER - PER FILTRO
1786283	∅ 25.5x21x5 mm	VIBIEMME	FOR BREW GROUPS - PER GRUPPI EROGAZIONE
3786502	∅ 25.7x21.2x5 mm	EXPOBAR	---
1186516	∅ 26x17x2 mm	SPAZIALE	FOR HEATING ELEMENTS - PER RESISTENZE
1186118	∅ 26x19x2 mm	FIorenzato	FOR STEAM/WATER TAPS - PER RUBINETTI VAPORE/ACQUA
1186117	∅ 26x21x2 mm	MANY BRANDS - MOLTI MARCHI	SEVERAL APPLICATIONS - MOLTE APPLICAZIONI
1186537	∅ 26x22x2 mm	EXPOBAR	FOR BREW GROUPS - PER GRUPPI EROGAZIONE
1186537	∅ 26x22x2 mm	PAVONI	FOR BREW GROUPS - PER GRUPPI EROGAZIONE
1186127	∅ 27x20x0.5 mm	FAEMA	FOR INLET TAPS - PER RUBINETTI CARICO
1186248	∅ 27x20x1 mm	CASADIO	FOR BREW GROUPS - PER GRUPPI EROGAZIONE
1186248	∅ 27x20x1 mm	FAEMA	FOR STEAM/WATER TAPS - PER RUBINETTI VAPORE/ACQUA
1186290	∅ 27x21x2 mm	SAN MARCO	FOR BREW GROUPS - PER GRUPPI EROGAZIONE
1186281	∅ 28x23x2 mm	PAVONI	FOR STEAM/WATER TAPS - PER RUBINETTI VAPORE/ACQUA
1186281	∅ 28x23x2 mm	SAN MARCO	FOR BREW GROUPS - PER GRUPPI EROGAZIONE
1186770	∅ 33x28x4 mm	ASTORIA/CMA	FOR BREW GROUPS - PER GRUPPI EROGAZIONE
1186361	∅ 34x27x2 mm	SAN MARCO	FOR BREW GROUPS - PER GRUPPI EROGAZIONE
3186665	∅ 35x21x2 mm	---	---
1186328	∅ 35x30x2 mm	MANY BRANDS - MOLTI MARCHI	SEVERAL APPLICATIONS - MOLTE APPLICAZIONI
1186307	∅ 36x30x2 mm	MANY BRANDS - MOLTI MARCHI	SEVERAL APPLICATIONS - MOLTE APPLICAZIONI
3786512	∅ 40x34x3 mm	CONTI	---
1186993	∅ 42x33x3 mm	BEZZERA	FOR HEATING ELEMENTS - PER RESISTENZE
1186243	∅ 42x34x0.5 mm	FAEMA	FOR BREW GROUPS - PER GRUPPI EROGAZIONE
1186608	∅ 50x40x2 mm	ASTORIA/CMA - SAN MARCO - SPAZIALE	FOR HEATING ELEMENTS - PER RESISTENZE
1186994	∅ 50x40x5.5 mm	SAN MARCO	FOR BREW GROUPS - PER GRUPPI EROGAZIONE
1186800	∅ 50x44x4 mm	FIorenzato - VIBIEMME	FOR BREW GROUPS - PER GRUPPI EROGAZIONE
1186979	∅ 52x40x2 mm	EXPOBAR	FOR HEATING ELEMENTS - PER RESISTENZE
1186979	∅ 52x40x2 mm	QUICK MILL	FOR HEATING ELEMENTS - PER RESISTENZE
1186623	∅ 53x43x3 mm	MANY BRANDS - MOLTI MARCHI	FOR HEATING ELEMENTS - PER RESISTENZE
3743110	∅ 57x41x2 mm	---	---
1186179	∅ 57x43x3 mm	MANY BRANDS - MOLTI MARCHI	FOR HEATING ELEMENTS - PER RESISTENZE
1186194	∅ 58x43x2 mm	ASTORIA/CMA - ORCHESTRALE	FOR HEATING ELEMENTS - PER RESISTENZE
1186609	∅ 58x51x2 mm	CIMBALI	FOR HEATING ELEMENTS - PER RESISTENZE
1186639	∅ 62x51x2 mm	SPAZIALE	FOR HEATING ELEMENTS - PER RESISTENZE
1186455	∅ 65x47x1.5 mm	RANCILIO - PROMAC	FOR HEATING ELEMENTS - PER RESISTENZE
1186409	∅ 68x55x3 mm	NUOVA SIMONELLI	FOR HEATING ELEMENTS - PER RESISTENZE
1186188	∅ 72x61x2 mm	ASTORIA/CMA	FOR HEAT EXCHANGES - PER SCAMBIATORE
1186297	∅ 73x61x3 mm	---	---
1186155	∅ 76x68.4x3 mm	CONTI	FOR HEATING ELEMENTS - PER RESISTENZE
1786213	∅ 85x70x2 mm	---	---

## ROTARY VANE PUMPS PROCON



1

2

3

4

5

Photo	LF Code	Flow rate (l/h)	Connections (∅)	Suitable for
1	1330012	200	3/8" NPT	ALL BRANDS - TUTTE LE MARCHE
1	1330024	100	3/8" NPT	PAVONI
1	1330019	100	3/8" NPT	CIMBALI - FAEMA - SPAZIALE
2	1330016	200	3/8" NPT	ALL BRANDS - TUTTE LE MARCHE
3	1330033	180	3/8"	CASADIO - CIMBALI - FAEMA
4	1330011	200	3/8" NPT	FAEMA
5	1330017	150	3/8"	CASADIO - CIMBALI - FAEMA



**ROTARY VANE PUMPS ROTOFLOW**



Photo	LF Code	Flow rate (l/h)	Connections (ø)	Suitable for
1	1330021	50	3/8"	ALL BRANDS - TUTTE LE MARCHE
1	1330034	70	3/8"	ALL BRANDS - TUTTE LE MARCHE
1	1330008	150	3/8"	ALL BRANDS - TUTTE LE MARCHE
1	1330026	200	3/8"	ALL BRANDS - TUTTE LE MARCHE
1	1330001	100	3/8" NPT	ALL BRANDS - TUTTE LE MARCHE
1	1330029	150	3/8" NPT	ALL BRANDS - TUTTE LE MARCHE
1	1330002	200	3/8" NPT	ALL BRANDS - TUTTE LE MARCHE
1	1330101	100	3/8" NPT ECO BRASS	ALL BRANDS - TUTTE LE MARCHE
1	1330102	200	3/8" NPT ECO BRASS	ALL BRANDS - TUTTE LE MARCHE
1	1330030	200	3/8"	RANCILIO 10705960
2	1330025	70	3/8"	ALL BRANDS - TUTTE LE MARCHE
2	1330004	100	3/8" NPT	ALL BRANDS - TUTTE LE MARCHE
3	1330022	50	3/8"	ALL BRANDS - TUTTE LE MARCHE
3	1330005	100	3/8"	ALL BRANDS - TUTTE LE MARCHE
3	1330122	50	3/8" ECO BRASS	ALL BRANDS - TUTTE LE MARCHE
4	1330031	150	3/8"	CASADIO - CIMBALI - FAEMA
5	1330003	200	3/8" NPT	FAEMA - GRIMAC
6	1330006	200	3/8"	UNIC

**SELECTOR SWITCHES ROYAL**



1

Photo	LF Code	Positions number	Contact capacity	Suitable for	For machine model
1	1057022	0-1	25A 690V	ROYAL 5005120	SYNCHRO

## SHOWER SCREENS ROYAL



Photo	LF Code	Dimensions	Suitable for	For machine model
1	1081007	∅ 51.5 mm	ROYAL 4630033	SYNCHRO
2	1081016	∅ 60.0 mm	ROYAL 0520080	DIADEMA
3	1081116	∅ 60.0 mm	ROYAL 0520080	DIADEMA
4	1081216	∅ 60.0 mm	ROYAL 0520080	DIADEMA
5	1081516	∅ 60.0 mm	ROYAL 0520080	DIADEMA

## SOLENOID VALVES AE



Photo	LF Code	Connections (∅)	Outlet (∅)	Coil type	Suitable for
1	1120169	1/8	7 mm	13VA 220/240V 50Hz	GRIMAC MG355/1
1	1120169	1/8	7 mm	13VA 220/240V 50Hz	LAVAZZA 10079018
1	1120169	1/8	7 mm	13VA 220/240V 50Hz	SPINEL SR.000.032.012
2	1120256	1/8	7 mm	13VA 220/240V 50Hz	SPINEL SR.000.032.015
3	1120183	1/8	---	13VA 220/240V 50Hz	FIAMMA 4.0.002.0041

## SOLENOID VALVES CEME 2 WAYS



Photo	LF Code	Connections (∅)	Orifice (∅)	Seal	Model	Coil type	Suitable for
1	1120230	1/4	2.5	VITON	6712	B6 17VA 230V 50Hz	---
1	1120231	1/4	2.8	VITON	6712	B6 17VA 230V 50Hz	---
2	1120232	1/4	3.0	VITON	6612	B6 17VA 230V 50Hz	---
3	1120236	1/8	2.0	VITON	5220	B4 13.5VA 230V 50Hz	---
3	1120186	1/8	2.0	VITON	5510	B4 13.5VA 230V 50Hz	RDL 14210040
4	1120237	1/8	2.0	VITON	5220	B4 13.5VA 230V 50Hz	---
4	1120238	1/8	2.0	VITON	5220	B4 14VA 100/120V 60Hz	---
5	1120254	QUICK - RAPIDI	2.7	NBR	5220	B4 13.5VA 230V 50Hz	DELONGHI 5213210171
5	1120250	QUICK - RAPIDI	2.7	VITON	5220	B4 13.5VA 230V 50Hz	DELONGHI 5213215771



Photo	LF Code	Connections ( $\varnothing$ )	Orifice ( $\varnothing$ )	Seal	Model	Coil type	Suitable for
6	1120471	1/4	3.0	VITON	6660	B6 17VA 230V 50Hz	NUOVA SIMONELLI 04100024

## SOLENOID VALVES CEME 3-WAYS



Photo	LF Code	Connections ( $\varnothing$ )	Orifice ( $\varnothing$ )	Seal	Outlet ( $\varnothing$ )	Model	Coil type	Suitable for
1	1120228	---	1.5	VITON	1/8	6270	B6 17VA 230V 50Hz	---
2	1120229	1/8	1.5	VITON	1/8	6211	B6 17VA 230V 50Hz	---
3	1120233	1/8	1.2	VITON	7 mm	5320	B4 13.5VA 230V 50Hz	---
3	1120174	1/8	2.0	VITON	7 mm	5315	B4 13.5VA 230V 50Hz	LAVAZZA 10079018
3	5020858	1/8	2.0	VITON	7 mm	5320	B4 17VA 208/240V 50/60Hz	NUOVA SIMONELLI 04100054
4	1120234	1/8	1.2	VITON	7 mm	5320	B4 13.5VA 230V 50Hz	---
4	1120235	1/8	1.2	VITON	7 mm	5320	B4 14VA 100/120V 60Hz	---
5	1120257	QUICK - RAPIDI	2.7	VITON	7 mm	5301	B4 13.5VA 230V 50Hz	DELONGHI 5213214021

## SOLENOID VALVES LUCIFER 2 WAYS



Photo	LF Code	Connections ( $\varnothing$ )	Orifice ( $\varnothing$ )	Seal	Model	Coil type	Suitable for
1	1120331	---	3.5	RUBINO	121FS1651A	9W 220/240V 50/60Hz	ALL BRANDS - TUTTE LE MARCHE
1	5501168	---	3.5	RUBINO	121FS1651B	9W 24VCC	RANCILIO 34040027
2	1120192	---	1.5	RUBINO	121F4417	9W 220/240V 50/60Hz	CASADIO 533898300R
2	1120192	---	1.5	RUBINO	121F4417	9W 220/240V 50/60Hz	FAEMA 533898300R
2	1120241	---	1.5	RUBINO	121F4417	9W 24VAC 50/60Hz	CIMBALI 533-893-300
3	1120460	1/8	2.5	VITON	7121ZBG1LV00	9W 220/240V 50/60Hz	ALL BRANDS - TUTTE LE MARCHE
3	1120466	1/8	2.5	VITON	7121ZBG1LV00	9W 110/115/120V 50/60Hz	CIMBALI
3	1120461	1/8	2.5	RUBINO	7121ZBG1LR00	9W 220/240V 50/60Hz	ALL BRANDS - TUTTE LE MARCHE



## SOLENOID VALVES LUCIFER 3 WAYS



1

2

Photo	LF Code	Connections ( $\varnothing$ )	Orifice ( $\varnothing$ )	Seal	Outlet ( $\varnothing$ )	Model	Coil type	Suitable for
1	1120330	---	2.5	RUBINO	1/8 CONIC	E131F4304	9W 220/240V 50/60Hz	ALL BRANDS - TUTTE LE MARCHE
1	1120102	---	1.5	RUBINO	1/8 CONIC	E131F4304	9W 110/115/120V 50/60Hz	ALL BRANDS - TUTTE LE MARCHE
1	5069161	---	2.5	RUBINO	1/8 CONIC	E131F4304	9W 24VAC 50/60Hz	ALL BRANDS - TUTTE LE MARCHE
2	1120334	---	1.5	RUBINO	1/8 CONIC	E131F4304	---	ALL BRANDS - TUTTE LE MARCHE

## SOLENOID VALVES M&M



1

2

3

Photo	LF Code	Connections ( $\varnothing$ )	Orifice ( $\varnothing$ )	Seal	Outlet ( $\varnothing$ )	Model	Coil type	Suitable for
1	1120167	1/8	1.2	VITON	6.5	B397	2700 10VA 230/240V 50/60Hz	LAVAZZA 10079018
1	1120167	1/8	1.2	VITON	6.5	B397	2700 10VA 230/240V 50/60Hz	SPINEL SR.000.032.001
2	1120502	1/8	2.0	VITON	1/8	B397	2700 10VA 230/240V 50/60Hz	---
3	1120501	1/8	2.0	VITON	---	B297DVE	2700 10VA 230/240V 50/60Hz	GRIMAC 1160400045-V190
3	1120501	1/8	2.0	VITON	---	B297DVE	2700 10VA 230/240V 50/60Hz	SPINEL SR.000.032.000

## SOLENOID VALVES ODE 2 WAYS



1

2

3

4

Photo	LF Code	Connections ( $\varnothing$ )	Orifice ( $\varnothing$ )	Seal	Outlet ( $\varnothing$ )	Model	Coil type	Suitable for
1	1120805	---	1.5	RUBINO	1/8 CONIC	31A	8W 220/230V 50/60Hz	ALL BRANDS - TUTTE LE MARCHE
1	1120812	---	1.5	RUBINO	1/8 CONIC	31A	8W 110V 60Hz	ALL BRANDS - TUTTE LE MARCHE
1	1120801	---	1.5	RUBINO	1/8	31A	8W 220/230V 50/60Hz	LAVAZZA 10063303
1	1120810	---	3.0	VITON	1/8 CONIC	31A	24VAC 50/60Hz	ALL BRANDS - TUTTE LE MARCHE
2	1120809	---	1.5	RUBINO	1/8 CONIC	31A	8W 220/230V 50/60Hz	ALL BRANDS - TUTTE LE MARCHE
3	1120806	1/8	1.5	RUBINO	1/8 CONIC	31A	8W 220/230V 50/60Hz	NUOVA SIMONELLI 04100009
3	2102059	1/8	1.5	VITON	1/8 CONIC	31A	8W 220/230V 50/60Hz	MARZOCCO L100/E
3	1120202	1/8	1.5	VITON	1/8 CONIC	31A	8W 24VDC	---
3	1120815	1/8	3.0	VITON	1/8 CONIC	31A	8W 110V 60Hz	---



Photo	LF Code	Connections ( $\varnothing$ )	Orifice ( $\varnothing$ )	Seal	Outlet ( $\varnothing$ )	Model	Coil type	Suitable for
4	5053805	1/8	1.2	VITON	1/8	31J	5W 230/240V 50/60Hz	BEZZERA 7702316

## SOLENOID VALVES ODE 2 WAYS



Photo	LF Code	Connections ( $\varnothing$ )	Orifice ( $\varnothing$ )	Seal	Outlet ( $\varnothing$ )	Model	Coil type	Suitable for
1	1120123	1/8	1.1	VITON	6.6	31A	8W 220/230V 50/60Hz	SAECO 9121.138.00A
1	1120180	1/8	1.1	VITON	6.6	31A	8W 24VDC	SAECO 9121.138.00P
2	1120166	1/8	1.0	VITON	6.6	31A	8W 220/230V 50/60Hz	LAVAZZA 10063970
3	1120121	1/8	1.2	VITON	6.6	31J	5W 230/240V 50/60Hz	NUOVA SIMONELLI 04100046
4	1120136	1/8	1.2	VITON	6.6	31J	---	---
4	1120137	1/8	2.3	VITON	6.6	31J	---	---

## SOLENOID VALVES ODE2 WAYS



Photo	LF Code	Connections ( $\varnothing$ )	Orifice ( $\varnothing$ )	Seal	Model	Coil type	Suitable for
1	1120802	---	2.0	RUBINO	21A	8W 220/230V 50/60Hz	BIANCHI 25034316
1	1120811	---	2.0	RUBINO	21A	8W 110V	---
2	1120804	1/8	3.0	RUBINO	21A	8W 220/230V 50/60Hz	---
2	1120808	1/8	3.0	VITON	21A	8W 220/230V 50/60Hz	DALLA CORTE B-00-0027
2	1120814	1/8	3.0	RUBINO	21A	8W 110V	---
2	1120813	1/8	3.0	VITON	21A	8W 110V	---
2	1120164	1/4	1.1	VITON	21A	8W 220/230V 50/60Hz	---
2	1120816	1/4	2.0	VITON	21A	8W 110V	---
2	1120134	1/4	2.5	VITON	21A	8W 220/230V 50/60Hz	---
2	1120803	1/4	3.0	VITON	21A	8W 220/230V 50/60Hz	---
2	1120215	1/4	4.5	VITON	21A	8W 24VDC	---
2	5033799	1/4	5.5	VITON	21A	8W 24VAC 50/60Hz	SPAZIALE 04843
2	1120346	1/4	5.5	VITON	520	12W 24VDC	MARZOCCO B.2.020
3	1120040	1/4	2.2	VITON	21T	8W 220/230V 50/60Hz	NUOVA SIMONELLI 04100003
3	1120807	1/4	2.8	VITON	21T	8W 220/230V 50/60Hz	---
4	1120039	1/4	2.5	VITON	417	8W 220/230V 50/60Hz	CONTI 367910
5	1120248	1/4	3.0	EPDM	21A	8W 220/230V 50/60Hz	ASTORIA/CMA 18161981
5	1120248	1/4	3.0	EPDM	21A	8W 220/230V 50/60Hz	WEGA WY18161981
6	1120012	1/8	2.3	VITON	21J	5W 230V 50/60Hz	ECM MANUFACTURE C199900275
6	1120012	1/8	2.3	VITON	21J	5W 230V 50/60Hz	NUOVA SIMONELLI 04100042
6	1120012	1/8	2.3	VITON	21J	5W 230V 50/60Hz	SAN MARCO 108677
6	1120157	1/8	2.3	VITON	21J	5W 220V 60Hz	CONTI 411476

## SOLENOID VALVES OLAB 3 WAYS



Photo	LF Code	Connections ( $\varnothing$ )	Orifice ( $\varnothing$ )	Seal	Outlet ( $\varnothing$ )	Model	Coil type	Suitable for
1	1120004	---	1.4	VITON	7 mm	8000/7	15VA 220/230V 50Hz	BRASILIA 01984.4.00.08
1	1120004	---	1.4	VITON	7 mm	8000/7	15VA 220/230V 50Hz	ISOMAC IS000200
2	1120187	1/8	1.5	VITON	7 mm	9000/FZ	9VA 230V 50Hz	RDL 14210010
2	1120107	1/8	1.5	VITON	7 mm	9000/H	10W 24VDC	---
3	1120188	1/8	1.1	VITON	7 mm	9500/HEVT9000	9/12VA 230V 50Hz	SAECO 11011462
4	1120366	---	1.4	VITON	7 mm	8000/3	15VA 220/230V 50Hz	GAGGIA DM1645/001

## SOLENOID VALVES PARKER 2 WAYS



Photo	LF Code	Connections ( $\varnothing$ )	Orifice ( $\varnothing$ )	Seal	Model	Coil type	Suitable for
1	1120352	---	2.5	VITON	VE125CV2	9W 220/230V 50/60Hz	ALL BRANDS - TUTTE LE MARCHE
1	1120154	---	2.5	VITON	VE125CV2	9W 110/120V 50/60Hz	ALL BRANDS - TUTTE LE MARCHE
1	1120258	---	1.5	VITON	VE125ASV	9W 220/230V 50/60Hz	VIBIEMME ELETELE2VBABV
2	1120260	1/8	1.5	VITON	VE146V	9W 220/230V 50/60Hz	VIBIEMME ELETELE2VAU22
2	1120700	1/8	2.5	VITON	VE146FV	9W 220/230V 50/60Hz	ALL BRANDS - TUTTE LE MARCHE
2	1120155	1/8	2.5	VITON	VE146V	9W 110/120V 50/60Hz	ALL BRANDS - TUTTE LE MARCHE
2	1120261	1/8	3.0	VITON	VE146V	9W 220/230V 50/60Hz	VIBIEMME ELETELE2AU22
2	1120151	1/8	3.0	VITON	VE146HV	9W 110/120V 50/60Hz	ALL BRANDS - TUTTE LE MARCHE
2	1120243	1/4	1.5	VITON	VE146V	9W 220/230V 50/60Hz	GAGGIA DM1197/220/5060
2	1120354	1/4	2.5	VITON	VE146NV	9W 220/230V 50/60Hz	ALL BRANDS - TUTTE LE MARCHE
2	1120153	1/4	3.0	VITON	VE146YV	9W 110/120V 50/60Hz	ALL BRANDS - TUTTE LE MARCHE
2	1120259	1/4	4.5	VITON	VE146.3KV	14W 220/230V 50/60Hz	VIBIEMME ELETELE2A2245
3	1120355	1/8	2.5	RUBINO	VE1402IR	9W 220/230V 50/60Hz	ALL BRANDS - TUTTE LE MARCHE
3	5019899	1/8	2.5	VITON	501FG1LVG7	9W 220/240V 50/60Hz	SANREMO 10303108
3	5019235	1/8	2.5	VITON	7121Z	9W 24VAC 50/60Hz	CIMBALI 533-798-400
3	5019235	1/8	2.5	VITON	7121Z	9W 24VAC 50/60Hz	FAEMA 533798400
3	1120106	1/8	3.0	VITON	7121Z NFS	16W 24VDC	CIMBALI 533-896-600
4	1120246	1/4	2.2	VITON	VE161.4EV	9W 220/230V 50/60Hz	BIANCHI 25034216
4	1120048	1/4	2.0	VITON	VE161.4QVFOV	9W 220/230V 50Hz	EXPOBAR 60000100
5	1120010	1/8	1.5	VITON	746BVRF6	9W 220/230V 50/60Hz	SPAZIALE 00907
6	5019884	---	2.0	VITON	175BV	6W 220/230V 50/60Hz	SANREMO 10303080



**SOLENOID VALVES PARKER 3 LIQUIPURE**



Photo	LF Code	Connections ( $\varnothing$ )	Orifice ( $\varnothing$ )	Seal	Outlet ( $\varnothing$ )	Model	Coil type	Suitable for
1	1120750	---	1.5	RUBINO	1/8 CONIC	3019	9W 220/240V 50/60Hz	---
1	1120751	---	1.5	RUBINO	1/8 CONIC	3019	9W 24VAC 50/60Hz	CIMBALI 533-900-400
1	1120751	---	1.5	RUBINO	1/8 CONIC	3019	9W 24VAC 50/60Hz	FAEMA 533900400
2	1120701	---	1.5	RUBINO	---	2019	9W 220/240V 50/60Hz	---
3	1120558	---	1.5	RUBINO	1/8 CONIC	3019	---	---
3	1120562	---	1.5	VITON	1/8 CONIC	3019	---	---
3	1120560	---	2.5	RUBINO	1/8 CONIC	3019	---	---
3	1120564	---	2.5	VITON	1/8 CONIC	3019	---	---
4	1120550	---	1.5	RUBINO	---	2019	---	---
4	1120554	---	1.5	VITON	---	2019	---	---
4	1120552	---	2.5	RUBINO	---	2019	---	---
4	1120556	---	2.5	VITON	---	2019	---	---
5	1120541	1/4	---	---	---	INOX - NSF	---	---
5	1120540	1/8	---	---	---	INOX - NSF	---	---

**SOLENOID VALVES PARKER 3 LIQUIPURE**



Photo	LF Code	Connections ( $\varnothing$ )	Orifice ( $\varnothing$ )	Seal	Outlet ( $\varnothing$ )	Model	Coil type	Suitable for
1	1120582	---	---	---	---	XS03XS	9W 220/240V 50/60Hz	---
1	1120580	---	---	---	---	XS03M	9W 24VAC 50/60Hz	---
1	1120581	---	---	---	---	XS03XS	9W 110/115/120V 50/60Hz	---
2	1120583	---	---	---	---	LAXS6	9W 220/240V 50/60Hz	---
3	1786221	---	---	---	---	---	---	CIMBALI 539-901-000
4	5034989	---	---	---	---	M4x8	---	---



## SOLENOID VALVES PARKER 3 WAYS



Photo	LF Code	Connections ( $\varnothing$ )	Orifice ( $\varnothing$ )	Seal	Outlet ( $\varnothing$ )	Model	Coil type	Suitable for
1	1120335	---	1.3	RUBINO	1/8 CONIC	VE128IR	9W 220/230V 50/60Hz	ALL BRANDS - TUTTE LE MARCHE
1	1120350	---	1.3	RUBINO	1/8 CONIC	VE128IR	9W 24VAC 50/60Hz	ALL BRANDS - TUTTE LE MARCHE
1	1120101	---	1.3	RUBINO	1/8 CONIC	VE128IR	9W 110/120V 50/60Hz	ALL BRANDS - TUTTE LE MARCHE
2	1120351	---	1.3	RUBINO	1/8	VE128GR	9W 220/230V 50/60Hz	BRASILIA - GAGGIA
3	1120349	---	1.3	RUBINO	1/8 CONIC	VE128IR	9W 220/230V 50/60Hz	ALL BRANDS - TUTTE LE MARCHE
3	1120264	---	---	VITON	1/8 CONIC	VE128V	9W 220/230V 50/60Hz	EXPOBAR 60000112
4	1120476	---	1.3	RUBINO	1/8 CONIC	VE128IR	9W 220/230V 50/60Hz	FUTURMAT 07976608
5	1120339	---	1.3	RUBINO	1/8 CONIC	VE128IR	---	ALL BRANDS - TUTTE LE MARCHE
5	1120439	---	1.3	VITON	1/8 CONIC	PM128IV	---	ALL BRANDS - TUTTE LE MARCHE
6	1120265	---	1.3	RUBINO	1/8	VE128GR	---	BRASILIA - GAGGIA

## SOLENOID VALVES PARKER 3 WAYS



Photo	LF Code	Connections ( $\varnothing$ )	Orifice ( $\varnothing$ )	Seal	Outlet ( $\varnothing$ )	Model	Coil type	Suitable for
1	1120321	1/8	2.0	VITON	1/8 CONIC	VE141BV	9W 220/230V 50/60Hz	ALL BRANDS - TUTTE LE MARCHE
1	1120152	1/8	2.0	VITON	1/8 CONIC	VE141BV	9W 110/120V 50/60Hz	ALL BRANDS - TUTTE LE MARCHE
1	5039016	1/8	3.0	VITON	1/8 CONIC	VE141.2YV	9W 220/230V 50/60Hz	RENEKA 9007411
1	5069160	1/4	2.5	VITON	1/8 CONIC	VE141GV	9W 24VAC 50/60Hz	ALL BRANDS - TUTTE LE MARCHE
2	1120263	1/8	1.3	VITON	1/8 CONIC	148IV	9W 220/230V 50/60Hz	BEZZERA 7702311
3	1120088	1/8	2.0	VITON	7 mm	N79.6QV	6W 220/230V 50/60Hz	ALL BRANDS - TUTTE LE MARCHE
4	2102097	---	1.5	VITON	1/8 CONIC	VE108BV	14W 220/230V 50/60Hz	MARZOCCO B.2.004



**SOLENOID VALVES SIRAI 2 WAYS**



Photo	LF Code	Connections ( $\varnothing$ )	Orifice ( $\varnothing$ )	Seal	Model	Coil type	Suitable for
1	1120309	1/4	2.3	RUBINO	L121C01	9W 230V 50Hz	SPAZIALE 06478
1	1120310	1/4	2.5	VITON	L121V02	9W 230V 50Hz	NUOVA SIMONELLI 04100012
1	1120310	1/4	2.5	VITON	L121V02	9W 230V 50Hz	SPAZIALE 06478
1	1120316	1/4	3.2	EPDM	L121D04	9W 230V 50Hz	---
2	1120240	1/4	4.8	EPDM	L121D14	14VA 230V 50Hz	ASTORIA-CMA 18161977
2	1120240	1/4	4.8	EPDM	L121D14	14VA 230V 50Hz	WEGA WY18161977
3	1120308	1/8	2.3	VITON	L120V02	9W 230V 50Hz	FUTURMAT 07467400
4	2102747	1/8	2.4	VITON	L172V23	4W 230V 50/60Hz	QUICK MILL EV08700R

**SOLENOID VALVES SIRAI 3 WAYS**



Photo	LF Code	Connections ( $\varnothing$ )	Orifice ( $\varnothing$ )	Seal	Outlet ( $\varnothing$ )	Model	Coil type	Suitable for
1	1120306	---	1.6	RUBINO	1/8 CONIC	L334C18C	9W 230V 50Hz	ALL BRANDS - TUTTE LE MARCHE
1	1120242	---	1.6	RUBINO	1/8 CONIC	L334C18C	14VA 24VAC 50/60Hz	ALL BRANDS - TUTTE LE MARCHE
2	1120239	1/8	3.2	EPDM	1/8 CONIC	L321D08C	14VA 230V 50Hz	ASTORIA-CMA 18161976
2	1120239	1/8	3.2	EPDM	1/8 CONIC	L321D08C	14VA 230V 50Hz	WEGA WY18161976

**SPACERS**



Photo	LF Code	Dimensions (mm)	Material
1	1190101	$\varnothing$ 64x53x0.7	PAPER/CARTA
1	1190021	$\varnothing$ 66x58x0.8	PAPER/CARTA
1	1190006	$\varnothing$ 69x57x0.8	PAPER/CARTA
1	1190005	$\varnothing$ 70x57x0.5	PAPER/CARTA
1	1190051	$\varnothing$ 70x57x0.8	PAPER/CARTA
1	1190011	$\varnothing$ 72x58x0.8	PAPER/CARTA
1	1190001	$\varnothing$ 73x59x0.8	PAPER/CARTA



Photo	LF Code	Dimensions (mm)	Material
2	1190007	∅ 64x53x1.0	EPDM
2	1190003	∅ 70x57x1.0	EPDM
2	1190002	∅ 73x59x1.0	EPDM
3	1190004	∅ 71x58x0.6	VITON

## SPECIFIC SPOUTS - VARIOUS BRANDS



Photo	LF Code	Connection (∅)
1	1022032	3/8
2	1022059	3/8
3	1022505	3/8
4	1022550	3/8
5	1022099	3/8

## SPECIFIC SPOUTS - VARIOUS BRANDS



Photo	LF Code	Connection (∅)
1	1022102	3/8
2	1022506	3/8
3	1022524	3/8
4	1022531	3/8
5	1022532	M18
6	1022004	3/8



**SPRINGS ROYAL**



Photo	LF Code	Dimensions	Notes	Suitable for	For machine model
1	1250415	∅ 10x32 mm	FOR STEAM/WATER TAPS - PER RUBINETTI VAPORE/ACQUA	ROYAL 0540070	DIADEMA - SYNCHRO
2	1250536	∅ 13x42 mm	FOR BREW GROUPS - PER GRUPPI EROGAZIONE	ROYAL 0530030	DIADEMA - SYNCHRO
3	1250515	∅ 14x33 mm	FOR BREW GROUPS - PER GRUPPI EROGAZIONE	ROYAL 0530045	DIADEMA - SYNCHRO
4	1250537	∅ 14x45 mm	FOR BREW GROUPS - PER GRUPPI EROGAZIONE	ROYAL 0530030	DIADEMA - SYNCHRO
5	1250516	∅ 15x28 mm	FOR BREW GROUPS - PER GRUPPI EROGAZIONE	ROYAL 0530095	DIADEMA - SYNCHRO

**STEAM-WATER PIPES ROYAL**



Photo	LF Code	Notes	Suitable for	For machine model
1	1449167	H 105 mm	ROYAL 2520015	DIADEMA - SYNCHRO
2	1449332	---	ROYAL	DIADEMA - SYNCHRO

**STEAM-WATER TAPS ROYAL**



Photo	LF Code	Suitable for	For machine model
1	1348056	ROYAL 3501030	DIADEMA - SYNCHRO
2	1349064	ROYAL 0540135	DIADEMA - SYNCHRO
3	1186244	ROYAL 0540060	DIADEMA - SYNCHRO



## SWITCHES ROYAL



1

Photo	LF Code	Notes	Suitable for	For machine model
1	3319933	SWITCH - INTERRUTTORE / 16A 250V	ROYAL 5003080	DIADEMA

## UNIVERSAL CONTACT THERMOSTATS



1



2



3



4



5



6

Photo	LF Code	Temperature °C
1	1443017	85
1	1444506	90
1	1443010	93
1	1444003	95
1	1443005	98
1	1443011	100
1	1443072	104
1	1443400	107
1	1443071	110
1	3443081	125
1	1443401	135
1	1443004	145
2	1443070	135
2	1444206	145
2	1443002	165
3	1443079	95
3	3443026	110
3	5027936	125
3	1443066	130
3	1444521	155
3	1443034	200
4	5027937	170
4	1443012	180
5	1443055	125
5	5035435	140
5	1443063	143
6	1443030	---



UNIVERSAL FILTER HOLDER KNOBS



Photo	LF Code	Connection	Suitable for
1	1241505	M10	ALL BRANDS - TUTTE LE MARCHE
1	1241504	M12	ALL BRANDS - TUTTE LE MARCHE
2	1241269	M10	ALL BRANDS - TUTTE LE MARCHE
2	1241169	M12	ALL BRANDS - TUTTE LE MARCHE
3	1241502	M10	ALL BRANDS - TUTTE LE MARCHE
3	1241501	M12	ALL BRANDS - TUTTE LE MARCHE

UNIVERSAL FILTER HOLDER KNOBS



Photo	LF Code	Connection	Suitable for
1	5051751	M10	ALL BRANDS - TUTTE LE MARCHE
1	5051102	M12	ALL BRANDS - TUTTE LE MARCHE
2	5054506	M10	ALL BRANDS - TUTTE LE MARCHE
2	5054505	M12	ALL BRANDS - TUTTE LE MARCHE

UNIVERSAL FILTER HOLDER KNOBS



Photo	LF Code	Connection	Suitable for
1	1141006	M10	ALL BRANDS - TUTTE LE MARCHE
1	1141007	M12	ALL BRANDS - TUTTE LE MARCHE
2	1141004	M10	ALL BRANDS - TUTTE LE MARCHE
2	1141003	M12	ALL BRANDS - TUTTE LE MARCHE



## VARIOUS CAPPUCCINATORE



Photo	LF Code	Suitable for
1	1079016	BIANCHI - SAN MARCO
2	1079030	ASTORIA/CMA - MCE - ORCHESTRALE
3	1079023	ASTORIA/CMA - CARIMALI - NUOVA SIMONELLI - WEGA
4	1079009	SAECO
5	1079010	SAECO
6	5501292	PAVONI

## VENT VALVES



Photo	LF Code	Technical notes	Suitable for
1	1523537	∅ 1/4" M VITON	ALL BRANDS - TUTTE LE MARCHE
2	1523534	∅ 1/4" M PTFE AND VITON	ALL BRANDS - TUTTE LE MARCHE
3	1523538	∅ 1/4" M	ALL BRANDS - TUTTE LE MARCHE

## VIBRATORY PUMPS ULKA



Photo	LF Code	Model	Watt - Volt	Connections
1	1331018	EP4	48W 230V 50Hz	∅ 1/8" - ∅ 6 mm
1	1122738	EP5	48W 24V 50/60Hz	∅ 1/8" - ∅ 6 mm
1	1122737	EP5	48W 230V 50Hz	∅ 1/8" - ∅ 6 mm
1	1331037	EP8	26W 230/240V 50Hz	∅ 1/8" - ∅ 6 mm
2	1122002	EP5GW	48W 230V 50Hz	∅ 1/8" - ∅ 6 mm
2	1331026	EP5GW	48W 230V 50Hz	countersunk - svasata ∅ 1/8" - ∅ 6 mm
2	1331028	EP8GW	26W 230V 50Hz	∅ 1/8" - ∅ 6 mm
3	1122746	EX4	48W 230V 50Hz	∅ 1/8" - ∅ 6 mm
3	1122747	EX4	48W 24V 50/60Hz	∅ 1/8" - ∅ 6 mm
3	1122735	EX5	48W 230V 50Hz	∅ 1/8" - ∅ 6 mm
3	1122739	EX5	48W 230V 50Hz	countersunk - svasata ∅ 1/8" - ∅ 6 mm
3	1122736	EX5	48W 24V 50/60Hz	∅ 1/8" - ∅ 6 mm



Photo	LF Code	Model	Watt - Volt	Connections
3	1122740	EX5	48W 24V 50/60Hz	countersunk - svasata $\varnothing$ 1/8" - $\varnothing$ 6 mm
3	1331036	EX7	48W 24V 50/60Hz	$\varnothing$ 1/8" - $\varnothing$ 6 mm
3	1120025	EX7	48W 230V 50Hz	countersunk - svasata $\varnothing$ 1/8" - $\varnothing$ 6 mm
4	1331029	EX4GW	48W 230V 50/60Hz	$\varnothing$ 1/8" - $\varnothing$ 6 mm
4	1331006	EX5GW	48W 230V 50Hz	$\varnothing$ 1/8" - $\varnothing$ 6 mm
4	1331016	EX7GW	48W 230V 50Hz	$\varnothing$ 1/8" - $\varnothing$ 6 mm
5	1122601	EX5	41W 120V 60Hz	$\varnothing$ 1/8" - $\varnothing$ 6 mm
5	1122603	EX5	41W 120V 60Hz	countersunk - svasata $\varnothing$ 1/8" - $\varnothing$ 6 mm
5	2101958	EAX5	52W 120V 60Hz	$\varnothing$ 1/8" - $\varnothing$ 6 mm
6	2102265	EP5	41W 120V 60Hz	$\varnothing$ 1/8" - $\varnothing$ 6 mm
6	5062552	EAP5	52W 120V 60Hz	$\varnothing$ 1/8" - $\varnothing$ 6 mm
6	1122748	EK	54W 230V 50Hz	$\varnothing$ 1/8" - $\varnothing$ 6 mm

## VOLUMETRIC FLOWMETERS GICAR



Photo	LF Code	Model	Suitable for	For machine model
1	1455067	9.0.55.02G / $\varnothing$ 1/4"FF / $\varnothing$ 1.15 mm	ASTORIA/CMA 18126	ARGENTA - BRAVA - DIVINA - DORA - GLORIA - GLORIA R12
1	1455067	9.0.55.02G / $\varnothing$ 1/4"FF / $\varnothing$ 1.15 mm	BEZZERA 7431001	B2000 - B2006 - B2009 COMPACT - B2013 - B3000 - B4000
1	1455067	9.0.55.02G / $\varnothing$ 1/4"FF / $\varnothing$ 1.15 mm	BFC 5032012	CLASSICA - DELUX - GALILEO - GRANDOGE - IMOLA - JUNIOR
1	1455067	9.0.55.02G / $\varnothing$ 1/4"FF / $\varnothing$ 1.15 mm	BRUGNETTI-AURORA 95.01205	---
1	1455005	9.0.78.02G / $\varnothing$ 1/4"FF / $\varnothing$ 1.15 mm	CONTI 403466V	SK2
1	1455067	9.0.55.02G / $\varnothing$ 1/4"FF / $\varnothing$ 1.15 mm	EXPOBAR 60100045	ELEN - EXPRESSO - G10 - MARKUS - MARKUS SILVER
1	1455067	9.0.55.02G / $\varnothing$ 1/4"FF / $\varnothing$ 1.15 mm	FIorenzato CS A1500026	BRICOLETTA - DUCALE - FENICE - LIDO - VENEZIA
1	1455067	9.0.55.02G / $\varnothing$ 1/4"FF / $\varnothing$ 1.15 mm	FUTURMAT 08307500	ARIETE - F3 - RIMINI
1	1455060	9.0.93.02G / $\varnothing$ 1/4"FF / $\varnothing$ 1.15 mm	GAGGIA 11013052	DECO - GD - GE - XD - XE
1	1455067	9.0.55.02G / $\varnothing$ 1/4"FF / $\varnothing$ 1.15 mm	GRIMAC 1160900001-GR102	MIA - NEW CIALDA VAPOR - SELENITE DOUBLE - TWENTY
1	1455067	9.0.55.02G / $\varnothing$ 1/4"FF / $\varnothing$ 1.15 mm	MCE 18126	START
1	1455067	9.0.55.02G / $\varnothing$ 1/4"FF / $\varnothing$ 1.15 mm	NUOVA SIMONELLI 04900027	APPIA - APPIA COMPACT - AURELIA - AURELIATI - MACDIGIT
1	1455067	9.0.55.02G / $\varnothing$ 1/4"FF / $\varnothing$ 1.15 mm	ORCHESTRALE D18126	ETNICA - PHONICA
1	1455067	9.0.55.02G / $\varnothing$ 1/4"FF / $\varnothing$ 1.15 mm	RENEKA 9008954	LC - LIFE - PRESTIGE - VIVA
1	1455067	9.0.55.02G / $\varnothing$ 1/4"FF / $\varnothing$ 1.15 mm	ROYAL 5032012	DIADEMA - SYNCHRO
1	1455060	9.0.93.02G / $\varnothing$ 1/4"FF / $\varnothing$ 1.15 mm	SAECO 11013052	AROMA
1	1455067	9.0.55.02G / $\varnothing$ 1/4"FF / $\varnothing$ 1.15 mm	SAN MARCO 108192	NEW 105 - 100 - 105 - 85 - 95
1	1455067	9.0.55.02G / $\varnothing$ 1/4"FF / $\varnothing$ 1.15 mm	SANREMO 10112131A	MILANO LX
1	1455067	9.0.55.02G / $\varnothing$ 1/4"FF / $\varnothing$ 1.15 mm	SCALA C-0215	BUTTERFLY - CARMEN - EROICA
1	1455067	9.0.55.02G / $\varnothing$ 1/4"FF / $\varnothing$ 1.15 mm	VIBIEMME ELETCONTVOLOT	CHIMAERA - CUBO - DOMOBARSUPER - DOSAPLUS - EVOLUTION
1	1455067	9.0.55.02G / $\varnothing$ 1/4"FF / $\varnothing$ 1.15 mm	VICTORIA ARDUINO 04900027	ADONIS - VENUS CENTURY
1	1455067	9.0.55.02G / $\varnothing$ 1/4"FF / $\varnothing$ 1.15 mm	WEGA WY18126	ATLAS - ATLAS 10 - COLOSSEUM - COMBI NOVA - CONCEPT
2	1455068	9.0.55.50G / $\varnothing$ 1/8"FF / $\varnothing$ 1.15 mm	BRASILIA 16054.2.00.08	ROMA
2	1455068	9.0.55.50G / $\varnothing$ 1/8"FF / $\varnothing$ 1.15 mm	CIMBALI 534-391-020	M20 - M21 JUNIOR - M22 - M27 - M27 START - M28 - M29
2	1455068	9.0.55.50G / $\varnothing$ 1/8"FF / $\varnothing$ 1.15 mm	FAEMA 534391020	E98 COMPACT
2	1455068	9.0.55.50G / $\varnothing$ 1/8"FF / $\varnothing$ 1.15 mm	FIAMMA RST 5.0.000.1012	ATLANTIC - MARINA - PRESTIGE
2	1455068	9.0.55.50G / $\varnothing$ 1/8"FF / $\varnothing$ 1.15 mm	PAVONI 438020	---
2	1455068	9.0.55.50G / $\varnothing$ 1/8"FF / $\varnothing$ 1.15 mm	SANREMO 10112290	AMALFI - CAPRI - PISA - TORINO - VERONA - ZOE
3	1455026	9.0.54.05G / $\varnothing$ 1/4"FF / $\varnothing$ 1.15 mm	FRACINO FC92	BAMBINO
3	1455026	9.0.54.05G / $\varnothing$ 1/4"FF / $\varnothing$ 1.15 mm	MARZOCCO LAD070	FB70 - FB80 - GB5 - GS3 - LINEA - MISTRAL
3	1455352	9.0.78.00G / $\varnothing$ 1/4"FF / $\varnothing$ 1.15 mm	PROMAC 34070050	CLUB - COMPACT - GREEN
3	1455352	9.0.78.00G / $\varnothing$ 1/4"FF / $\varnothing$ 1.15 mm	RANCILIO 34070050	CLASSE10 - CLASSE9 - EPOCA
4	1455001	9.0.69.03G / $\varnothing$ 1/4"FF / $\varnothing$ 1.15 mm	SPAZIALE 02498	NEW - RAPID - S1 - S2 - S3 - S40 - S5 - S8



## VOLUMETRIC FLOWMETERS GICAR ACCESSORIES



Photo	LF Code	Model	Notes
1	3455333	9.0.16.50G	LED
2	5052706	9.0.15.51G	NO LED
3	1455032	6.9.23.05G	---
4	1186631	---	---
5	1455033	8.6.17.14	---

## WASHERS UNI ISO



LF Code	Dimensions	Suitable for	Notes
3528238	∅ 9x4x0.8 mm UNI 6592	GAGGIA S401004	FOR BREW GROUPS - PER GRUPPI EROGAZIONE
3528238	∅ 9x4x0.8 mm UNI 6592	GRIMAC GR356	G105 - G106
3528238	∅ 9x4x0.8 mm UNI 6592	PAVONI 401004	EUROPICCOLA - PROFESSIONAL - ROMANTICA - STRADIVARI
1528117	∅ 12x4x1 mm UNI 6593	GRIMAC 1300900128	SEVERAL APPLICATIONS - MOLTE APPLICAZIONI
1186192	∅ 10x5x1 mm UNI 6592	SPAZIALE 00246	FOR BREW GROUPS - PER GRUPPI EROGAZIONE
1186315	∅ 15x5x1.2 mm UNI 6593	CIMBALI 590-733-000	FOR LEVEL - PER LIVELLO
3528010	∅ 12x6x1.6 mm UNI 6592	FAEMA 4054043102	FOR BREW GROUPS - PER GRUPPI EROGAZIONE
3528010	∅ 12x6x1.6 mm UNI 6592	GRIMAC 1110400003-GR723	FOR BREW GROUPS - PER GRUPPI EROGAZIONE
3528010	∅ 12x6x1.6 mm UNI 6592	PAVONI 401061	FOR BREW GROUPS - PER GRUPPI EROGAZIONE
3528010	∅ 12x6x1.6 mm UNI 6592	SPAZIALE 01746	FOR BREW GROUPS - PER GRUPPI EROGAZIONE
1528008	∅ 16x8x1.6 mm UNI 6592	BRASILIA 01290.0.00.03	FOR BREW GROUPS - PER GRUPPI EROGAZIONE
1528008	∅ 16x8x1.6 mm UNI 6592	ELEKTRA 01816035	FOR BREW GROUPS - PER GRUPPI EROGAZIONE
1528008	∅ 16x8x1.6 mm UNI 6592	GAGGIA WGAUN6592-8Z	FOR BREW GROUPS - PER GRUPPI EROGAZIONE
1528008	∅ 16x8x1.6 mm UNI 6592	PAVONI 401065	FOR BREW GROUPS - PER GRUPPI EROGAZIONE
1528008	∅ 16x8x1.6 mm UNI 6592	SPAZIALE 00416	FOR BREW GROUPS - PER GRUPPI EROGAZIONE
1528008	∅ 16x8x1.6 mm UNI 6592	VIBIEMME VITERONGR8MA	FOR BREW GROUPS - PER GRUPPI EROGAZIONE
1528008	∅ 16x8x1.6 mm UNI 6592	RENEKA 9001335	FOR STEAM/WATER TAPS - PER RUBINETTI VAPORE/ACQUA
1528008	∅ 16x8x1.6 mm UNI 6592	VIBIEMME RACCROPIRU	FOR STEAM/WATER TAPS - PER RUBINETTI VAPORE/ACQUA
1528020	∅ 18x8x1.3 mm UNI 6593	PROMAC 32239044	FOR STEAM/WATER TAPS - PER RUBINETTI VAPORE/ACQUA
1528020	∅ 18x8x1.3 mm UNI 6593	RANCILIO 32239044	FOR STEAM/WATER TAPS - PER RUBINETTI VAPORE/ACQUA
1186504	∅ 20x10.6x2 mm UNI 6592	FAEMA 4041135933	FOR BREW GROUPS - PER GRUPPI EROGAZIONE
1186504	∅ 20x10.6x2 mm UNI 6592	PROMAC 39520008	FOR BREW GROUPS - PER GRUPPI EROGAZIONE
1186504	∅ 20x10.6x2 mm UNI 6592	RANCILIO 39520008	FOR BREW GROUPS - PER GRUPPI EROGAZIONE
3528211	∅ 28x15x2.5 mm UNI 6592	PAVONI 401075	FOR STEAM/WATER TAPS - PER RUBINETTI VAPORE/ACQUA



**WASHERS VARIOUS**



LF Code	Dimensions	Suitable for	Notes
1528054	∅ 12x5x1 mm	ASTORIA/CMA 23260014	FOR BREW GROUPS - PER GRUPPI EROGAZIONE
1528059	∅ 18x6.5x1.5 mm	BFC 0540030	FOR STEAM/WATER TAPS - PER RUBINETTI VAPORE/ACQUA
1186036	∅ 21.5x6.5x2 mm	BIANCHI 18004971	FOR STEAM/WATER TAPS - PER RUBINETTI VAPORE/ACQUA
1528059	∅ 18x6.5x1.5 mm	CARIMALI 93.00058	FOR STEAM/WATER TAPS - PER RUBINETTI VAPORE/ACQUA
1186299	∅ 22x16x1 mm	CASADIO 590715000	FOR STEAM/WATER TAPS - PER RUBINETTI VAPORE/ACQUA
1186299	∅ 22x16x1 mm	CIMBALI 590-715-000	FOR STEAM/WATER TAPS - PER RUBINETTI VAPORE/ACQUA
1186036	∅ 21.5x6.5x2 mm	EXPOBAR 25012521	FOR STEAM/WATER TAPS - PER RUBINETTI VAPORE/ACQUA
1186299	∅ 22x16x1 mm	FAEMA 590715000	FOR STEAM/WATER TAPS - PER RUBINETTI VAPORE/ACQUA
1186399	∅ 30x17x3 mm	GAGGIA WGAUN6592-17Z	FOR LEVEL - PER LIVELLO
1186299	∅ 22x16x1 mm	GRIMAC 1300900055-G207	FOR STEAM/WATER TAPS - PER RUBINETTI VAPORE/ACQUA
1528059	∅ 18x6.5x1.5 mm	MARZOCCO L165/9	FOR STEAM/WATER TAPS - PER RUBINETTI VAPORE/ACQUA
1186036	∅ 21.5x6.5x2 mm	MARZOCCO L165/9B	FOR STEAM/WATER TAPS - PER RUBINETTI VAPORE/ACQUA
1186399	∅ 30x17x3 mm	NUOVA SIMONELLI 00200011	FOR STEAM/WATER TAPS - PER RUBINETTI VAPORE/ACQUA
1186399	∅ 30x17x3 mm	SAECO WGAUN6592-17Z	FOR LEVEL - PER LIVELLO
1186142	∅ 23x15x0.5 mm	SAN MARCO 205584	FOR STEAM/WATER TAPS - PER RUBINETTI VAPORE/ACQUA
1528059	∅ 18x6.5x1.5 mm	SANREMO 10402040	FOR STEAM/WATER TAPS - PER RUBINETTI VAPORE/ACQUA
1186416	∅ 15x11x2 mm	SPAZIALE 00523	FOR STEAM/WATER TAPS - PER RUBINETTI VAPORE/ACQUA
1528141	∅ 22x6.5x5 mm	VIBIEMME RACCROBLMAEVO	FOR STEAM/WATER TAPS - PER RUBINETTI VAPORE/ACQUA
1528054	∅ 12x5x1 mm	WEGA WY23260014	FOR BREW GROUPS - PER GRUPPI EROGAZIONE

**WATER FILTERS**



Photo	LF Code	Dimensions	Suitable for
1	1160017	∅ 8x1.5 mm	SPAZIALE 02284
1	1160511	∅ 9x1.5 mm	CIMBALI 481-361-000
1	1160023	∅ 11x2 mm	SAN MARCO 202232
1	1160068	∅ 18 mm	CASADIO 490055000 - CIMBALI 490-055-000
2	1160400	∅ 11 mm	ASTORIA/CMA 10254 - WEGA WY10254
3	1160501	∅ 14x10x12 mm	ASTORIA/CMA 10252 - BEZZERA 5471002
3	1160501	∅ 14x10x12 mm	BRASILIA 00086.0.00.04 - PAVONI 330051
4	1160021	∅ 18x20 mm	ELEKTRA 00111035
5	1160801	M8x1	RANCILIO 10705003
6	1160012	∅ 11 mm	RANCILIO 10706070

## WATER FILTERS



Photo	LF Code	Dimensions	Suitable for
1	1160523	∅ 5.9 mm	CARIMALI 14.00795
1	1160311	∅ 7 mm	BIANCHI 43144416 - FUTURMAT 07362205
2	1160536	∅ 7 mm	SPAZIALE 00275
1	1160566	∅ 8 mm	ASTORIA/CMA 10251001 - WEGA WY10251001
1	1160566	∅ 8 mm	NUOVA SIMONELLI 98004001
1	1160011	∅ 9 mm	BRASILIA 09756.0.00.04 - CIMBALI 4771-116-081
1	1160516	∅ 11 mm	ASTORIA/CMA 10251002 - FUTURMAT 02435808
3	1160519	∅ 14 mm	PAVONI 326202
4	1160346	∅ 14 mm	CONTI 327154
5	1160087	∅ 15 mm	SANREMO 10052139A

## WATER FILTERS



Photo	LF Code	Dimensions	Suitable for
1	1160507	∅ 8.5x15 mm	FUTURMAT 08298700
2	1160517	∅ 8.5x22 mm	GROUP E61
3	1160074	∅ 8.5x25 mm	CIMBALI 533-100-400
4	1160338	∅ 8x13 mm	CONTI 403458

## WATER INLET TAPS ROYAL



Photo	LF Code	Notes	Suitable for	For machine model
1	1348344	3/8	ROYAL 0510150	---
2	1523401	∅ 6.5/12 mm - H 20 mm	ROYAL 0510166	---



Suitable for:

**ROYAL**



Suitable for:

**Clamps**

**1168011 STAINLESS STEEL CLAMP FOR FLANGE PUMP**



















ROYAL



*The data herewith contained may change without notice and LF SpA cannot be held responsible for possible errors stated or resulting by the use of this document. All rights reserved. No part of this publication may be reproduced without written permission by LF SpA.*



Distributing Components, Spare Parts & Accessories  
in original quality worldwide

- 
-  **LF SpA HEADQUARTERS**  
via Voltri, 80 - 47522 Cesena (FC) ITALY  
Tel. +39 0547 34 11 11 - Fax +39 0547 34 11 10  
[www.lfcomb724.it](http://www.lfcomb724.it) - [www.lfcomb724.mobi](http://www.lfcomb724.mobi) - [info@lfcomb.it](mailto:info@lfcomb.it)  
Export Dept.: Tel. +39 0547 34 11 50 - Fax: +39 0547 34 11 55  
[www.lfspareparts724.com](http://www.lfspareparts724.com) - [www.lfspareparts724.mobi](http://www.lfspareparts724.mobi)  
[export@lfspareparts.com](mailto:export@lfspareparts.com)
  -  **OOO LF RUSSIAN FEDERATION**  
Ul. Anatoliya Zhivova, 8 - office 1 - 123100 Moscow  
Tel. +7 499 259 85 75  
Fax +7 495 725 26 53  
[www.lfspareparts724.ru](http://www.lfspareparts724.ru)  
[www.lfspareparts724.mobi](http://www.lfspareparts724.mobi)  
[info@lfspareparts.ru](mailto:info@lfspareparts.ru)
  -  **EPGC Sas FRANCE**  
13, Rue des Forts - 59960 Neuville en Ferrain  
Tel. +33 (0)3 20 25 06 21  
Fax +33 (0)3 20 25 34 12  
[www.epgc.com](http://www.epgc.com)  
[www.epgc724.mobi](http://www.epgc724.mobi)  
[epgc@epgc.com](mailto:epgc@epgc.com)
  -  **LF Repuestos Horeca S.L.U. SPAIN**  
Calle Ciudad Real, 10 - 45517 Escalonilla - Toledo  
Tel. +34 91 477 91 00  
Fax +34 91 477 90 81  
[www.lfrepuestos-horeca724.es](http://www.lfrepuestos-horeca724.es)  
[www.lfrepuestos724.mobi](http://www.lfrepuestos724.mobi)  
[info@lfrepuestos.es](mailto:info@lfrepuestos.es)
  -  **LF GmbH GERMANY**  
Junkersstrasse, 1 - D-82178 Puchheim - München  
Tel. +49 89 89 45 78 66  
Fax +49 89 89 45 78 88  
[www.lfersatzteile724.de](http://www.lfersatzteile724.de)  
[www.lfersatzteile724.mobi](http://www.lfersatzteile724.mobi)  
[info@lfersatzteile.de](mailto:info@lfersatzteile.de)
  -  **LF SpA Cesena (IT) Swiss Branch Steinhausen SWITZERLAND**  
Sennweidstrasse, 45 - CH-6312 Steinhausen  
Tel. +41 (0)41 760 15 80-1  
Fax +41 (0)41 760 15 85  
[www.lfersatzteile724.ch](http://www.lfersatzteile724.ch)  
[www.lfersatzteilech724.mobi](http://www.lfersatzteilech724.mobi)  
[info@lfersatzteile.ch](mailto:info@lfersatzteile.ch)
  -  **LF China REPUBLIC OF CHINA**  
Room 403, No.2, Huadu Mansion, Lane 422, Huanghua Rd.  
Minhang Dist. - 201103 Shanghai  
Tel. +86 (0)21 33 53 66 31  
Fax +86 (0)21 33 53 66 32  
[www.lfspareparts724.com](http://www.lfspareparts724.com)  
[www.lfspareparts724.mobi](http://www.lfspareparts724.mobi)  
[china@lfspareparts.com](mailto:china@lfspareparts.com)
  -  **LF Spare Parts Ltd. UNITED KINGDOM**  
A10a Lakeside Business Park, Broadway Lane  
South Cerney, Gloucestershire GL7 5XL  
Tel. +44 (0)1285 86 16 25  
Fax +44 (0)1285 86 39 49  
[www.lfspareparts724.co.uk](http://www.lfspareparts724.co.uk)  
[www.lfspareparts724.mobi](http://www.lfspareparts724.mobi)  
[info@lfspareparts.co.uk](mailto:info@lfspareparts.co.uk)
- 
-  **AUSTRALIA AND NEW ZEALAND**  
[www.lfspareparts724.com](http://www.lfspareparts724.com)  
[andrea.calvio@lfspareparts.com](mailto:andrea.calvio@lfspareparts.com)
  -  **DENMARK**  
[www.lfspareparts724.dk](http://www.lfspareparts724.dk)  
[michael.lenth@lfspareparts.com](mailto:michael.lenth@lfspareparts.com)
  -  **AUSTRIA**  
[www.lfspareparts724.at](http://www.lfspareparts724.at)  
[ludwig.neier@lfersatzteile.at](mailto:ludwig.neier@lfersatzteile.at)
  -  **SOUTH KOREA**  
[www.lfspareparts724.com](http://www.lfspareparts724.com)  
[fabio.doni@lfspareparts.com](mailto:fabio.doni@lfspareparts.com)
  -  **BALKAN COUNTRIES**  
[www.lfspareparts724.com](http://www.lfspareparts724.com)  
[matija.ramov@lfspareparts.com](mailto:matija.ramov@lfspareparts.com)
  -  **TURKEY**  
[www.lfyedekparca724.com](http://www.lfyedekparca724.com)  
[basar.ergun@lfyedekparca.com](mailto:basar.ergun@lfyedekparca.com)
  -  **BALTIC COUNTRIES**  
[www.lfspareparts724.com](http://www.lfspareparts724.com)  
[inara.silina@lfspareparts.com](mailto:inara.silina@lfspareparts.com)
  -  **USA AND CANADA**  
[www.lfspareparts724.us](http://www.lfspareparts724.us)  
[sauro.dallaglio@lfspareparts.us](mailto:sauro.dallaglio@lfspareparts.us)  
[howard.truitt@lfspareparts.us](mailto:howard.truitt@lfspareparts.us)
  -  **CENTRAL AND EASTERN EUROPE**  
[www.lfspareparts724.cz](http://www.lfspareparts724.cz)  
[jiri.kremla@lfspareparts.cz](mailto:jiri.kremla@lfspareparts.cz)